



# **Will Rogers World Airport Development Standards Manual**

**May 6, 2010**



# Will Rogers World Airport Development Standards Manual

## Table of Contents

Section	Page
1. INTRODUCTION.....	1-1
1.1 Coordination.....	1-1
1.2 Purpose.....	1-1
2. GOVERNING REQUIREMENTS .....	2-1
2.1 Jurisdictions .....	2-1
2.2 General Provisions.....	2-1
2.4 Local Regulations and Building Codes .....	2-2
2.4.1 Airport Overlay District.....	2-3
2.4.2 FAA Requirements.....	2-3
2.4.3 Variances to Development Standards .....	2-4
3. PERFORMANCE STANDARDS.....	3-1
3.1 Noise .....	3-1
3.2 Air Emission .....	3-1
3.3 Heat.....	3-2
3.4 Glare and Light Interference .....	3-2
3.5 Industrial Waste Disposal .....	3-2
3.6 Electronic or Radio Interference .....	3-2
3.7 Vibration .....	3-2
3.8 Dust Control .....	3-2
3.9 Environmental Regulations .....	3-3
3.10 Permitted Uses.....	3-3
3.11 Prohibited Activities.....	3-4
4. GENERAL SITE DEVELOPMENT GUIDELINES.....	4-1
4.1 Site Planning .....	4-1
4.1.1 Traffic Management, Site Access and Egress.....	4-1
4.1.2 Functional Placement .....	4-2
4.1.3 Building Orientation.....	4-3
4.2 Screening .....	4-3
4.3 Setbacks .....	4-3
4.3.1 Landscape and Setbacks.....	4-4
4.3.2 Front Setbacks .....	4-4
4.3.3 Side Setbacks .....	4-5
4.3.4 Rear Setbacks.....	4-5
4.3.5 Paving Setbacks .....	4-5
4.3.6 Building Restriction Line .....	4-5



## Table of Contents (Cont'd.)

Section	Page
4.3.7 Exclusion from Setback Requirements .....	4-6
4.4 Site Coverage .....	4-6
4.5 Building Heights .....	4-6
4.6 Building Exterior Design Requirements .....	4-7
4.7 Building and Construction Materials .....	4-7
4.8 Aircraft Parking, Servicing and Taxiways .....	4-8
4.9 Aircraft Engine Exhaust Restrictions.....	4-8
4.10 Noise Exposure.....	4-8
4.11 Landscaping.....	4-9
4.12 Parking .....	4-12
4.13 Signage/Graphics.....	4-17
4.14 Site Lighting .....	4-20
4.15 Outside Storage .....	4-22
4.16 Utilities and Easements .....	4-24
4.17 Vehicular Access.....	4-24
4.18 Hedges and Fences.....	4-25
4.19 Airport Security.....	4-26
5. DEVELOPMENT REVIEW PROCESS .....	5-1
5.1 Overview .....	5-1
5.2. Development Approval Phases.....	5-2
6. AVIATION AND AVIATION SUPPORT DEVELOPMENT .....	6-1
6.1 Theme Statement.....	6-1
6.2 Building Massing .....	6-1
6.3 Single Occupancy Buildings .....	6-1
6.4 Multi – Occupancy Buildings.....	6-2
6.5 Building Materials.....	6-2
6.6 Roofs.....	6-2
6.7 Roof Drainage .....	6-2
6.8 Landscaping.....	6-3
7. NONAERONAUTICAL DEVELOPMENT .....	7-1
7.1 Theme Statement.....	7-1
7.2 Elevation & Massing Concepts .....	7-1
7.3 Building Massing .....	7-1
7.4 Building Materials.....	7-2
7.5 Roofs.....	7-2
7.6 Additional Landscaping/Berming .....	7-2
7.7 Drainage.....	7-3





**Table of Contents (Cont'd.)**

<b>Section</b>	<b>Page</b>
8. CONSTRUCTION REQUIREMENTS .....	8-1
8.1 Ground Lease .....	8-1
8.2 Contractors.....	8-1
8.3 Permits .....	8-1
8.4 Contractors Environmental Protection Plan.....	8-1
8.5 Security Requirements.....	8-2
8.6 Temporary Water Supply .....	8-2
8.7 Water Connections.....	8-2
8.8 Electrical and Telecommunications Services .....	8-2
8.9 Road Crossings – Site Services .....	8-2
8.10 Responsibility for Site Service Connections .....	8-2
8.11 Underground Services Specifications .....	8-3
8.12 Clean up and Reclamation.....	8-3
8.13 Temporary Buildings .....	8-3
8.14 Safety Program .....	8-3
8.15 Inspections .....	8-4
8.16 Record Documents Generated by Construction .....	8-4
8.17 Construction Standards .....	8-5
8.18 Project Control .....	8-5
8.19 Building Materials and Engineering .....	8-5
8.20 Type of Construction .....	8-5
8.21 Pipes .....	8-6
8.22 Hazardous Activities.....	8-6
8.23 Utility Line Connections .....	8-6
8.24 Excavation.....	8-7
8.25 Protection of Property and Work in Progress .....	8-7
8.26 Grading and Site Drainage .....	8-7
8.27 Sustainability/LEED.....	8-8
8.28 Site Access .....	8-8
8.29 Construction Maintenance .....	8-8
9. BUILDING DESIGN .....	9-1
9.1 Introduction and Approach.....	9-1
9.2 Basic Design Principles .....	9-1
9.3 Prohibited Features.....	9-1
9.4 Roof Forms, Drainage and Screening .....	9-2
9.5 Building Lighting.....	9-3

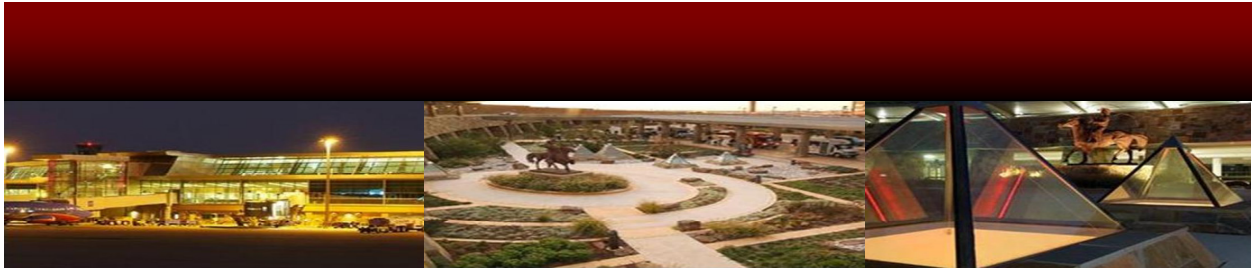

**Table of Contents (Cont'd.)**

<b>Section</b>		<b>Page</b>
10.	ARCHITECTURAL MATERIALS .....	10-1
10.1	Color Palette .....	10-1
10.2	Materials.....	10-1
10.3	Brick .....	10-2
10.4	Concrete Masonry Units .....	10-2
10.5	Stone Veneer .....	10-2
10.6	Metal Panel Systems .....	10-3
10.7	Architectural Metal Roofing.....	10-3
10.8	Stucco .....	10-4
10.9	Concrete (Vertical Surfaces).....	10-4
10.10	Glass and Frames.....	10-4
10.11	Paving .....	10-4
10.12	Hardscape.....	10-4
10.13	Wood.....	10-4
10.14	Fencing .....	10-5
10.15	Retaining Walls .....	10-5

**List of Appendices**

- Appendix A - FAA Form 7460 and Instructions
- Appendix B - Terminology Definitions



# Will Rogers World Airport Development Standards Manual - Abridged

## Table of Contents

Section	Page
1. INTRODUCTION.....	1-1
1.1 Coordination.....	1-1
1.2 Purpose.....	1-1
2. GOVERNING REQUIREMENTS .....	2-1
2.1 Jurisdictions .....	2-1
2.2 General Provisions.....	2-1
2.4 Local Regulations and Building Codes .....	2-2
2.4.1 Airport Overlay District.....	2-3
2.4.2 FAA Requirements.....	2-3
2.4.3 Variances .....	2-4
3. PERFORMANCE STANDARDS .....	3-1
3.1 Noise .....	3-1
3.2 Air Emission .....	3-1
3.3 Heat.....	3-2
3.4 Glare and Light Interference .....	3-2
3.5 Industrial Waste Disposal .....	3-2
3.6 Electronic or Radio Interference .....	3-2
3.7 Vibration.....	3-2
3.8 Dust Control .....	3-2
3.9 Environmental Regulations.....	3-3
3.10 Permitted Uses.....	3-3
3.11 Prohibited Activities.....	3-4
4. GENERAL SITE DEVELOPMENT GUIDELINES.....	4-1
4.1 Site Planning.....	4-1
4.1.1 Traffic Management, Site Access and Egress.....	4-1
4.1.2 Functional Placement .....	4-2
4.1.3 Building Orientation.....	4-3
4.2 Screening .....	4-3
4.3 Setbacks .....	4-3
4.3.1 Landscape and Setbacks.....	4-4
4.3.2 Front Setbacks .....	4-4
4.3.3 Side Setbacks .....	4-5
4.3.4 Rear Setbacks.....	4-5
4.3.5 Paving Setbacks .....	4-5
4.3.6 Building Restriction Line .....	4-5



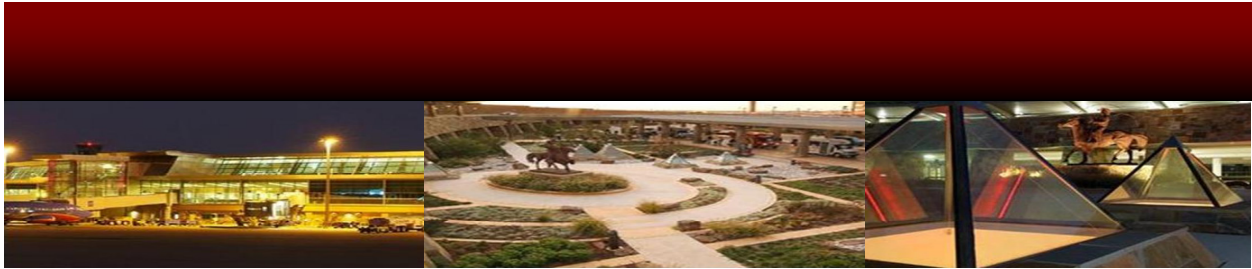

## Table of Contents (Cont'd.)

Section	Page
4.3.7 Exclusion from Setback Requirements .....	4-6
4.4 Site Coverage .....	4-6
4.5 Building Heights .....	4-6
4.6 Building Exterior Design Requirements .....	4-7
4.7 Building and Construction Materials .....	4-7
4.8 Aircraft Parking, Servicing and Taxiways .....	4-8
4.9 Aircraft Engine Exhaust Restrictions.....	4-8
4.10 Noise Exposure.....	4-8
4.11 Landscaping.....	4-9
4.12 Parking .....	4-12
4.13 Signage/Graphics.....	4-17
4.14 Site Lighting .....	4-20
4.15 Outside Storage .....	4-22
4.16 Utilities and Easements .....	4-24
4.17 Vehicular Access.....	4-24
4.18 Hedges and Fences.....	4-25
4.19 Airport Security.....	4-26
5. DEVELOPMENT REVIEW PROCESS .....	5-1
5.1 Overview .....	5-1
5.2. Development Approval Phases.....	5-2
6. RESERVED .....	6-1
7. RESERVED .....	7-1
8. CONSTRUCTION REQUIREMENTS .....	8-1
8.1 Ground Lease .....	8-1
8.2 Contractors.....	8-1
8.3 Permits .....	8-1
8.4 Contractors Environmental Protection Plan.....	8-1
8.5 Security Requirements.....	8-2
8.6 Temporary Water Supply .....	8-2
8.7 Water Connections.....	8-2
8.8 Electrical and Telecommunications Services .....	8-2
8.9 Road Crossings – Site Services .....	8-2
8.10 Responsibility for Site Service Connections .....	8-2
8.11 Underground Services Specifications .....	8-3
8.12 Clean up and Reclamation.....	8-3
8.13 Temporary Buildings .....	8-3
8.14 Safety Program .....	8-3
8.15 Inspections .....	8-4
8.16 Record Documents Generated by Construction .....	8-4



### Table of Contents (Cont'd.)

<b>Section</b>	<b>Page</b>
8.17 Construction Standards .....	8-5
8.18 Project Control .....	8-5
8.19 Building Materials and Engineering .....	8-5
8.20 Type of Construction .....	8-5
8.21 Pipes .....	8-6
8.22 Hazardous Activities.....	8-6
8.23 Utility Line Connections .....	8-6
8.24 Excavation.....	8-7
8.25 Protection of Property and Work in Progress .....	8-7
8.26 Grading and Site Drainage .....	8-7
8.27 Sustainability/LEED.....	8-8
8.28 Site Access .....	8-8
8.29 Construction Maintenance .....	8-8
 9. RESERVED .....	 9-1
 10. RESERVED .....	 10-1

### List of Appendices

- Appendix A - FAA Form 7460 and Instructions
- Appendix B - Terminology Definitions





# 1. INTRODUCTION

Will Rogers World Airport (WRWA or the Airport) is comprised of approximately 8,080 acres of land. An area of airport property from Portland Avenue east to I-44 and from SW 104th Street north to SW 59th Street has functioned mainly as a buffer zone between the Airport and various incompatible land uses. A development strategy/land use plan for this 1,000-acre property has been prepared to guide the future development of aviation and non-aviation land uses including commercial, industrial, and retail development. The main objective of the land use plan is to create an orderly and optimal mix of compatible land uses. The two primary goals established for the plan are as follows: 1) to create a long-term, self-sustaining source of revenue for the Oklahoma City Airport Trust; and 2) to promote economic development and create jobs in Oklahoma City.

This Development Standards document for commercial lands is part of the set of primary guiding documents established by the Oklahoma City Airport Trust (the Trust) that govern the operation, management and development of Will Rogers World Airport and in particular to guide the development of this prime airport property. Specifically, the purpose of this document is to convey the standards, guidelines, design criteria, policies and procedures to guide the development of aeronautical and nonaeronautical land improvements at the Airport. These Standards supplement the Will Rogers World Airport's (WRWA) Airport Strategic Development Program, by providing the parameters governing the design, construction, and modification of tenant facilities.

## 1.1 Coordination

The commercial land use development standards have been prepared to assist tenants in planning, designing, constructing and maintaining facilities at WRWA and the guidelines provided herein shall apply to all leasehold improvements identified as commercial development sites at WRWA. Refer to the Site Map for development locations (Exhibit 1.1).

The criteria in this document are intended to supplement the Airport Strategic Development Program that outlines the land development strategy and opportunities. Collectively, the requirements of these documents will be used to exercise control over development of these lands, ensure compatibility of all structures and improvements on the Airport and to ensure that the general aesthetic quality of leasehold improvements are consistent with the standards established for Will Rogers World Airport. The development review process and submission requirements are also outlined.

For the purposes of these Development Standards, the definitions of key terminology used within this document are provided in Appendix B.

## 1.2 Purpose

The main intent of the development standards is to ensure orderly development that includes a range of uses including airside aviation and aviation support and landside commercial and industrial. Special



attention was given towards the quality of buildings and the surrounding environment to complement the new terminal facility and provide a recognizable high quality identity for the Airport.

Specifically, the purpose of these guidelines is to:

- Promote consistent, attractive and compatible high quality development at the Airport;
- Establish clear direction for tenants and project designers without dictating absolute design styles;
- Maintain aesthetic excellence and high standards of environmental protection;
- Protect the interests of all tenants within the boundaries of WRWA;
- Maintain a sense of place and permanence for WRWA and surrounding community;
- Create standards for development that maintain the character of WRWA; and
- Extend the identity of the Airport throughout the extent of its property.

Will Rogers World Airport leases land for development in lieu of selling it. Therefore, the term “property line” and “lease line” may be used interchangeably and refer to the boundary of a leased parcel.

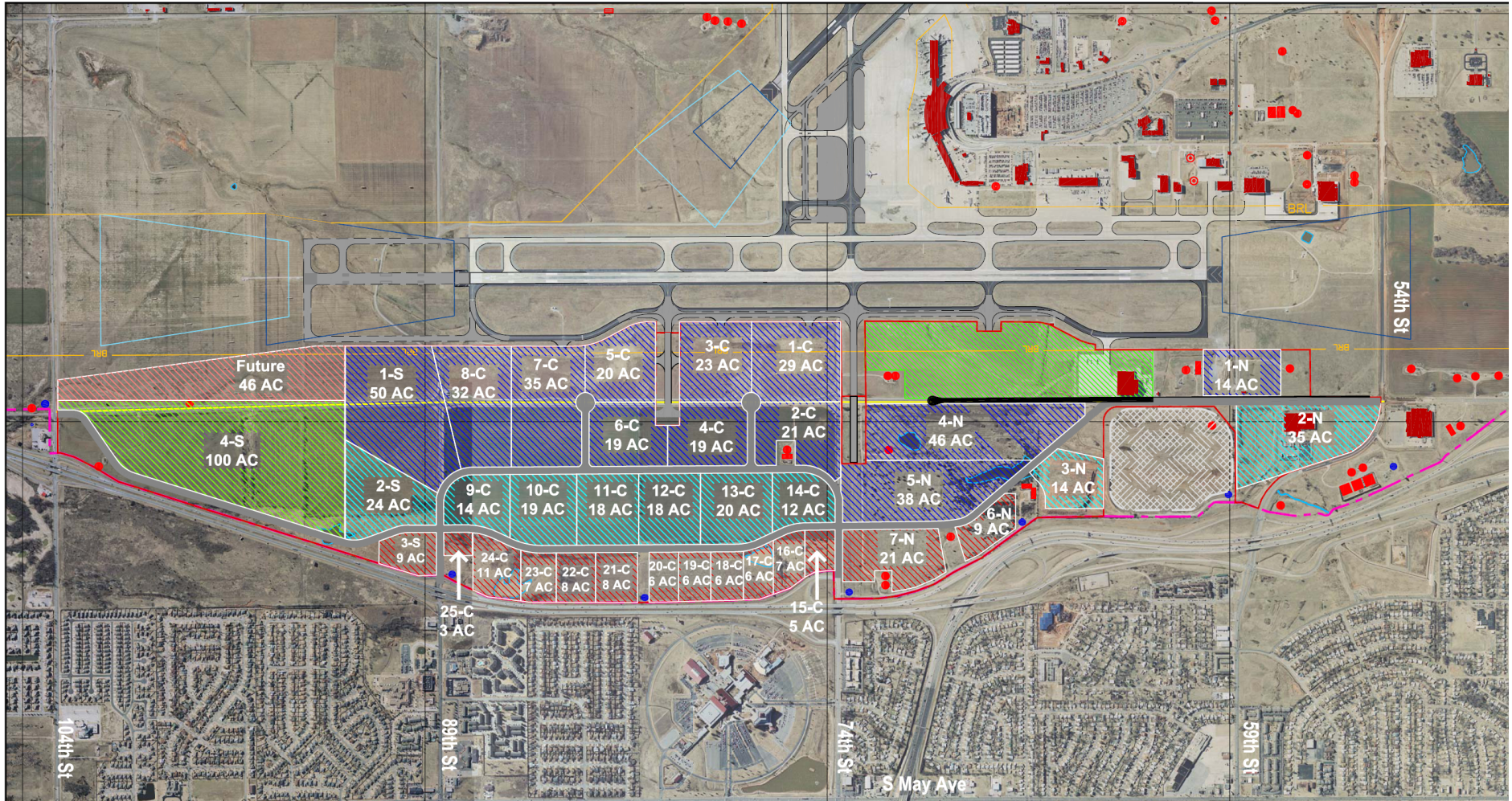

**LEGEND**

- |  |   |  |  |
|--|---|--|--|
|  | Existing airport property line            |  | Existing utilities corridor              |
|  | Development area                          |  | Stormwater detention pond                |
|  | Land developable after airfield expansion |  | Water well                               |
|  | Future airfield expansion                 |  | Oil well                                 |
|  | Existing Runway Protection Zone           |  | Existing road to remain                  |
|  | Future Runway Protection Zone             |  | Proposed road and utilities right-of-way |
|  | Building restriction line                 |  | Planned taxiway extension                |
|  |   |  | Potential taxiway extension              |

Source: Airport Layout Plan provided by Barnard Dunkelberg

**LAND USES**

- |  |   |
|--|---|
|  | Direct Aviation and Direct Aviation Support — w/ airfield access (346 acres)        |
|  | Direct Aviation Support and Indirect Aviation — w/o airfield access (174 acres)     |
|  | Nonaeronautical (112 acres)   |
|  | Strategic land reserve (100 acres)  |
|  | Land available for aviation-related development after airfield expansion (46 acres) |
- Note: Assumes a 100-ft right-of-way for the proposed roads and associated utilities corridors

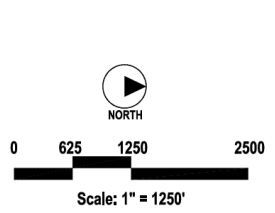
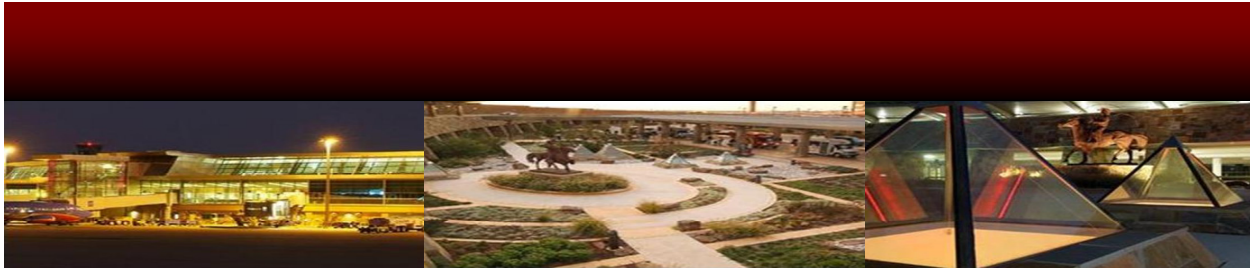

**Exhibit 1. AIRPORT PROPERTY DEVELOPMENT PLAN**

Strategic Development Plan  
Oklahoma City Will Rogers World Airport  
December 2005



Development Standards Manual  
March 2010



## **2. GOVERNING REQUIREMENTS**

### **2.1 Jurisdictions**

The Will Rogers World Airport is managed by the City of Oklahoma City's Department of Airports which is overseen by the Oklahoma City Airport Trust. The Trust shall evaluate all proposed development plans based on the standards defined herein, the details of the particular project, and the interests of stakeholders.

The Oklahoma City Department of Airports is responsible for managing and controlling the design, planning, construction, reconstruction and remodeling of all facilities within the boundaries of the Airport. No airport improvements shall be designed, planned, constructed, reconstructed or remodeled without the prior written approval of the Director of Airports.

Concurrent with the above design and environmental reviews, the Federal Aviation Administration (FAA) requires review and approval of Airport improvements. The Airport is required to submit "Form 7460" to the FAA detailing specific requirements of the project. The tenant shall submit all required information to the Director of Airports who shall in turn submit the information to the FAA. Submittal of this information shall be a prerequisite of the Director of Airports releasing final design approval. No construction shall commence without the written approval from FAA as per this Form. A copy of the form and associated instructions are provided in Appendix A.

### **2.2 General Provisions**

- The design and construction of all buildings must be in compliance with the current codes, ordinances, standards and regulations. Responsibility for obtaining appropriate approvals from government authorities and complying with their various regulations, policies and standards shall be that of the applicant.
- Tenants must obtain, at their expense, all permits required for their construction program. They shall pay all taxes, permits and all inspection fees and licenses required for the construction and operation for their business.
- The Airport encourages "designs of merit" which produce creative building and design solutions. Therefore any design which can be successfully demonstrated to WRWA as having merit will be considered for approval whether or not it strictly meets the specifics of the Development Standards.
- The design of any facility is to be carried out under the direction of a registered architect or engineer. All design drawings are to be prepared by a registered architect. Construction drawings are to be certified by their respective professional disciplines – architectural, structural, mechanical, electrical and civil engineers.

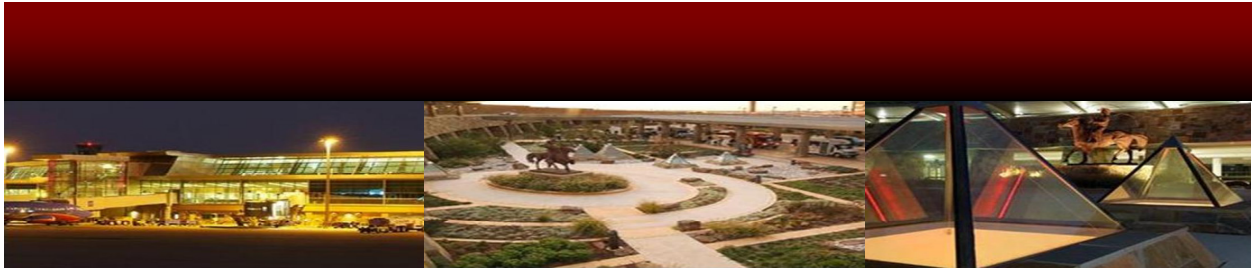

- Depending on the parcel location and position relative to the site, the Airport will provide infrastructure including taxiways or taxilanes, roads and connections to water, sewer and electrical systems. However, tenants shall be responsible for and incur all expenses for connection to all facility requirements including public roadways, aprons, taxiways, electrical power, communications, water, sewer and natural gas.
- Construction must commence within six (6) months from the final project approval by WRWA (see Section 5.2) and completion of the facility must be in accordance with an agreed construction schedule.
- Tenants must obtain the prior written approval from WRWA to modify, improve, add to or delete facilities from their leased area. If any structure is erected, placed, or altered upon in any other manner than in accordance with plans and specifications approved by WRWA, such construction will be considered to have been undertaken without approval. This restriction is applicable to landscaping plans as well as architectural plans.
- Tenants must suppress, at their own expense, and to the satisfaction of the FAA, all electromagnetic interference with radio guidance, safety devices or with any electric or electronic equipment or installations on or associated with the airport.
- All development must comply with Federal, state and local height limitations.
- The Airport assumes no responsibility with regard to the ability of the tenant to complete construction or otherwise meet the Terms and Conditions of the Lease, nor do they assume any responsibility for an error, fault or omission in the plans and specifications that have been approved. WRWA reserves the right to serve notice that action must be taken to remedy any improper situations.
- Noise, odors and smoke generation are of particular concern in the design and operation of any facility. Therefore any facility must be in compliance of Federal, state and local regulations applicable to WRWA.
- The Airport or its representative(s) shall have the right at reasonable times to visit sites and enter buildings which are completed or in the process of being built, changed, repaired, moved or demolished.

## **2.4 Local Regulations and Building Codes**

The Development Standards are designed to meet or exceed any applicable zoning, building codes and other governmental land-use statutes, ordinances, regulations, rules or other authority. Should any portion of the design standards be in conflict with or encourage violation of applicable statutes, codes, ordinances or other governmental regulations, those discrepancies shall fall under the jurisdiction of the most stringent ordinances or other regulation for all work performed on the premises by or on behalf of the applicant.

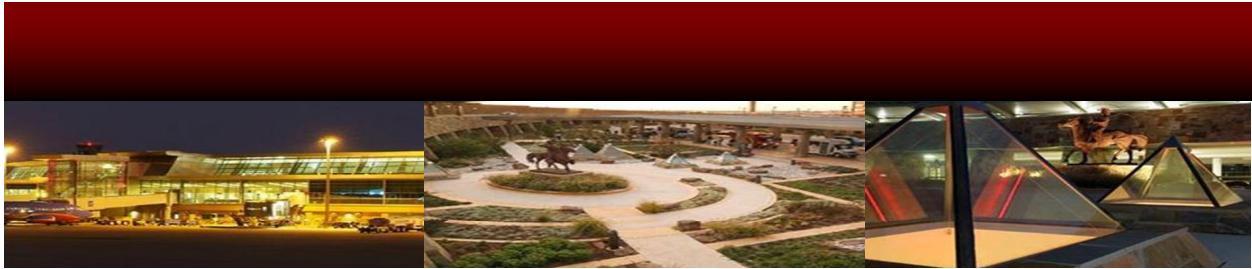

Obtaining a building permit starts with completing and submitting a building permit application with contact information of the owner, contractor and applicant, permit information, and the required number of complete sets of project plans in accordance with City of Oklahoma City requirements. The City of Oklahoma City Public Works Development Center staff can advise you when an architect or engineer is required. The degree of detail required depends on the project. Refer to the Commercial Development Checklist at [http://www.okc.gov/pw/pdf\\_files/Submit](http://www.okc.gov/pw/pdf_files/Submit) or discuss with Development Center staff.

The following regulations directly apply to development at the Airport:

- WRWA Zoning Overlay Districts defined for the Airport
- International Building Codes (IBC) as adopted by the City of Oklahoma City
- Oklahoma City municipal code and other related building regulations of the City of Oklahoma City and the County of Oklahoma. The State of Oklahoma does not require a license for general contractors. Electrical, plumbing, mechanical, sign, driveway and fire suppression system permits, however, can only be issued to contractors licensed in the State of Oklahoma and registered with the City of Oklahoma City. Currently the City of Oklahoma City is utilizing the following:
  - International Building Code, 2003
  - The 1995 CABO One and Two Family Dwelling Code
  - National Electrical Code, 2002
  - International Plumbing Code, 2000
  - International Mechanical Code, 1996
  - Associated Supplements to Each Code.
- Applicable Rules and Regulations for Landscaping
- WRWA Commercial Property Lease Policies

### **2.4.1 Airport Overlay District**

The City of Oklahoma City has prescribed two Airport Overlay Districts for the Will Rogers World Airport. The purpose of the airport overlay district is to protect the viability of the Airport as a significant resource to the community by encouraging compatible land use, densities, building heights and reducing hazards that may endanger the lives and property of the public and aviation users.

### **2.4.2 FAA Requirements**

The tenant is responsible for providing to the Airport all data required for submitting a Notice of Proposed Construction, Form 7460-1 (Appendix A), to the FAA for review and approval. The tenant shall submit this data once the Director of Airports has approved the building site location as discussed during the Pre-Design Phase. Form 7460-1 reviews take a minimum of 90 days to process and approve. No construction will be allowed to begin until an approved FAA 7460-1 form is on file with the Airport.



Design and construction shall be in accordance with the Federal Aviation Administration (FAA) Design Standards criteria where applicable as set forth in appropriate FAA Advisory Circulars (ACs) and Federal Aviation Regulations (FARs). The following FAA standards regulate the height and location, with respect to runways and taxiways, of all on-airport structures:

- FAR Part 77 “Objects Affecting Navigable Airspace”
- AC 150/5300-13 “Airport Design”
- FAA ACs may be obtained from [www.faa.gov](http://www.faa.gov) or:

U.S. Department of Transportation  
Subsequent Distribution Office  
Ardmore East Business Center  
3341 Q 75th Ave.  
Landover, MD 20785

### **2.4.3 Variances to Development Standards**

The Development Standards are designed to meet or exceed any applicable City zoning requirements. Should any portion of the Standards be in conflict with or encourage violation of applicable Statutes, Codes, Ordinances or other governmental regulations, those discrepancies shall fall under the jurisdiction of the most stringent Ordinances or other regulations for all work performed on the premises by or on behalf of the applicant. Variances to the development standards may be considered as a “Design of Merit” pending the initial review of the development proposal by the Airport.



### **3. PERFORMANCE STANDARDS**

The performance standards in this section shall be applicable to all land parcels.

#### **3.1 Noise**

Except for the proper operation and maintenance of aircraft or other air transportation equipment, the noise level generated on a building site, including but not limited to the noise from sound equipment, public address systems and sound production or reproduction devices, will not at any point on the lease line exceed:

- 75 decibels on the A-weighted scale (dBA) at any time
- 70 dBA for more than 1 minute out of an hour
- 65 dBA for more than 5 minutes out of an hour
- 60 dBA for more than 15 minutes out of an hour

The testing of aircraft engines or other engines will, at all times, be conducted in accordance with rules and regulations or operating directives established from time to time by the Airport.

Tenants also need to meet Oklahoma City municipal code regulations on sound level limits.

#### **3.2 Air Emission**

Except for the proper operation of aircraft or other air transportation equipment, the following requirements will apply:

- a. Any use producing atmospheric emissions will comply with standards established by the United States Environmental Protection Agency's ambient air quality standards, the Federal Clean Air Act of 1970 and Clean Air Act Amendments of 1990, as may be amended, or by any other federal, state, or local government authorities now or hereafter created which may have jurisdiction thereof.
- b. Any use producing smoke, gas, dust, odor, fumes, aerosols, particulates, products of combustion of any other atmospheric pollutant, will be conducted within a completely enclosed and properly ventilated building and will not result in any hazard to aviation or public safety.
- c. Any use that creates a nuisance, waste or injury on the premises, or elsewhere on the airport is not permitted.



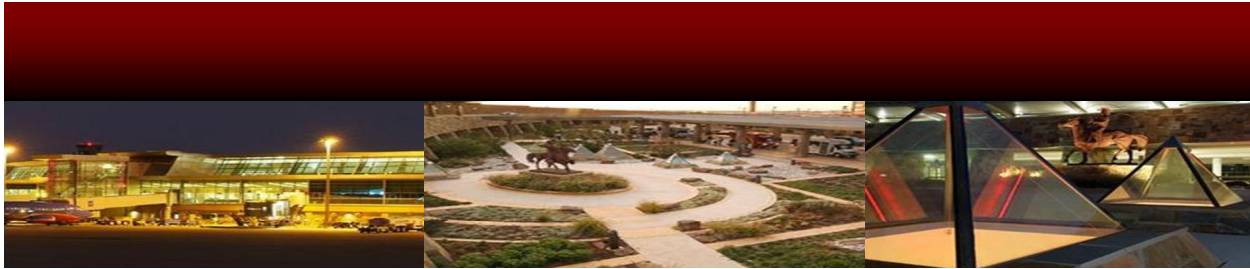

### **3.3 Heat**

Any operation producing heat shall be performed in an enclosed or screened area so that the heat emitted shall not be perceptible without the aid of instruments at any point beyond the leasehold boundaries of the parcel.

### **3.4 Glare and Light Interference**

Airport passenger convenience and aircraft operations require maximum visibility for the communication of information and operational safety. Therefore it is imperative that buildings exterior control solar glare. Maximum reflectivity of exterior surfaces should be 20%. Building interiors should also control glare to the extent that it does not interfere with programmed functions or passenger comfort and convenience.

Exterior site lighting shall be installed with shielding and be oriented to eliminate light spill beyond the property parcel boundary, or towards the FAA Air Traffic Control Tower (ATCT).

### **3.5 Industrial Waste Disposal**

No liquid waste disposal shall be allowed on the site, adjacent to drainage ditches, or onto adjacent property, or any other Airport property. All disposals of storm and sanitary sewage and industrial waste shall be in accordance with the applicable laws of the City of Oklahoma City, the State and Federal Government, and shall further be in compliance with the master drainage plan developed for the Airport.

All materials including rubbish, trash, garbage, maintenance, packing and container wastes, etc., shall be stored and all leasehold sites maintained in a manner that will not attract or aid the propagation of insects, birds or rodents, or anyway create a health hazard to the area.

### **3.6 Electronic or Radio Interference**

No activity will be conducted on a building site which would interfere with, obstruct, or adversely affect the operation of air navigation aids, airport radio communications, airport transportation systems, the flight operations of aircraft using the Airport. Also, no activity will be conducted within or on a building site in a manner which would interfere with, obstruct, or adversely affect the operation of the Airports' Wireless High Fidelity (WiFi) System.

### **3.7 Vibration**

No vibration shall be produced which is transmitted through the ground and is discernable without the aid of instruments at any point beyond the leasehold boundaries, except for vibrations associated with highway vehicles, ground equipment and aircraft.

### **3.8 Dust Control**

All ground areas not covered by structures shall be landscaped or paved with concrete, asphaltic concrete, or other comparable dust-free surfacing; shall be maintained in good condition, free of weeds,



dust, trash, and other debris; and shall be properly drained and graded. Such development shall be accomplished before issuance of a certificate of occupancy.

### 3.9 Environmental Regulations

Any use will comply with all applicable federal, state, and local environmental laws, ordinances, rules, regulations and orders.

### 3.10 Permitted Uses

This section describes typical permitted uses of available property. Buildings, structures, or land may be used for the following purposes, or any combination thereof:

**Aviation with Airfield Access.** In parcels designated as “aviation with airfield access”, acceptable uses include, but are not necessarily limited to:

- Air cargo facilities,
- Fixed base operators and associated activities (fueling, maintenance, hangar and tie-down rentals, flight school),
- Corporate aviation facilities,
- Commercial and/or charter service terminal,
- Aircraft maintenance facilities, and
- Aircraft manufacturing facilities.

**Aviation without Airfield Access.** In parcels designated as “aviation without airfield access”, acceptable uses include, but are not necessarily limited to:

- Freight forwarding facilities,
- Aircraft parts depot, and
- Retail - indirect aviation (supporting developed land uses).

**Nonaeronautical.** On parcels designated as “non-aviation”, anticipated acceptable uses include, but are not necessarily limited to:

- Office,
- Retail,
- Restaurants, including fast food establishments,
- Banks or banking facilities,



- Printing, reproduction, and photographic services,
- Office and graphics supplies,
- Commercial exercise clubs,
- Self-service gas stations,
- Institutional facilities, subject to WRWA approval, including government offices (Federal, State, and local), military recruitment, processing, and training centers, medical research, educational (especially aviation-oriented), and
- Light industrial, including light manufacturing, limited distribution activities, research and development facilities.

### **3.11 Prohibited Activities**

No use will be made of the Airport's improvements, buildings or building sites which is illegal, noxious, offensive, an unreasonable annoyance or a nuisance to others on or near the Airport. No activity will be conducted which could become dangerous to public health and safety or which will increase the fire insurance rating for adjoining or adjacent property.



## 4. GENERAL SITE DEVELOPMENT GUIDELINES

The criteria provided in this section shall apply to all commercial properties located within the Airport boundaries (Exhibit 1.1).

### 4.1 Site Planning

It is important that site planning receive primary attention and focus during the initial stages of the project design process. Placement of structures or improvements on the site shall be designed in such a way as to maximize the potential of the site.

Critical design performance includes traffic flow and safety, noise generation, air borne effluents and visual aesthetics. Particular consideration shall be given to building placement, landscape design, vehicular access, vehicular pedestrian circulation, and impact(s) to adjacent developments.

#### 4.1.1 *Traffic Management, Site Access and Egress*

There is a basic need to maintain smooth and safe vehicular traffic flows in the proximity of the development site. Land use relationships are most frequently characterized by the flow of traffic from the roadway onto the site, within the site, and back onto the roadway. Good management of this flow is determined by the success in which potential congestion at access and egress points is eliminated. The flow of traffic to and from adjacent sites and roadways must be considered when establishing access and egress points in the site layout.

- If the proposed site requires the conveyance of bulk materials by means of truck or tractor-trailer, it is recommended that the site be designed to separate truck or tractor-trailer traffic from employee traffic and particularly client, customer or visitor traffic.
- All sites shall incorporate maneuvering areas for larger vehicles to re-enter the public roadway in a forward direction.
- The maximum width recommended for any driveway is 30 feet. Turning radii of drives shall be designed to the recognized standards for the vehicle type anticipated.
- Drop-off deliveries of people, mail or packages may require a loading lane or temporary loading zone be provided to serve the primary entrance to a building.
- Long driveways within the site shall incorporate gently bent offsets which, with landscape planting features, will serve to interrupt the long axis view through the site as shown in Exhibit 4.1.

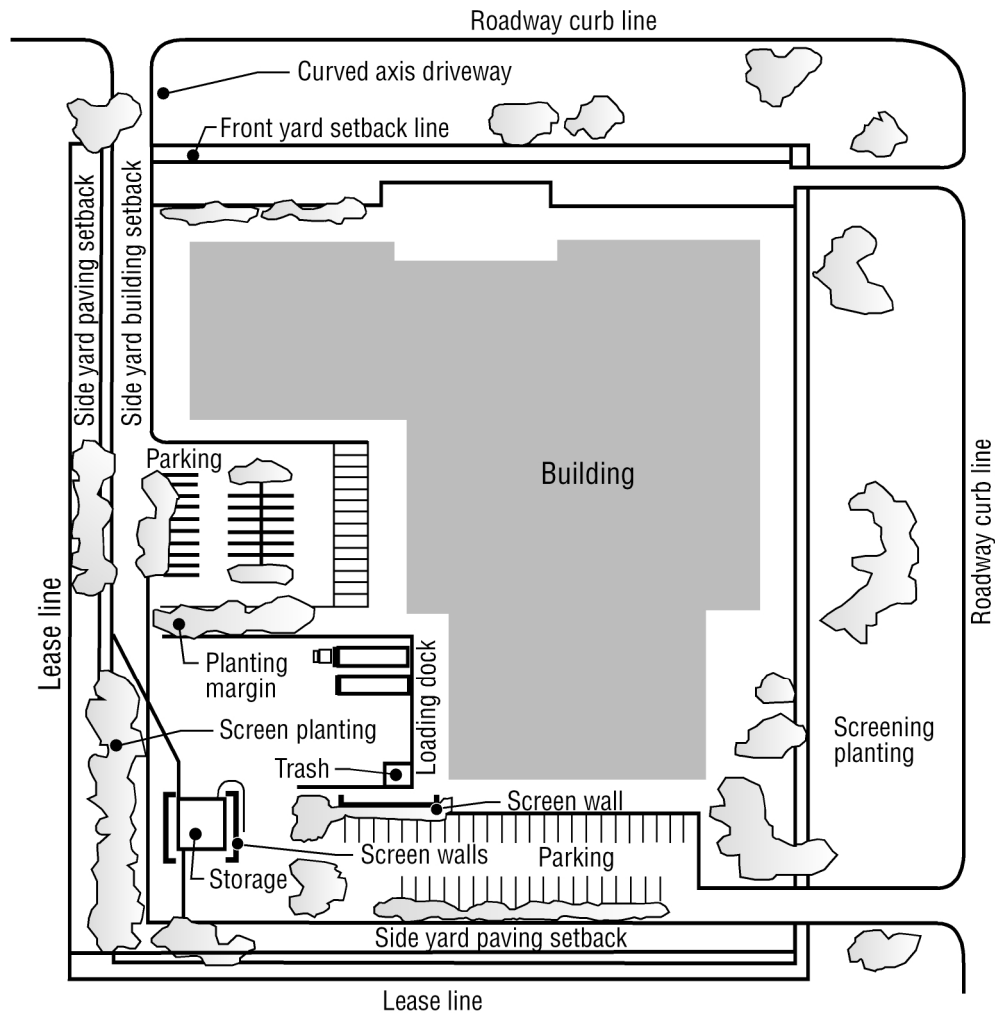
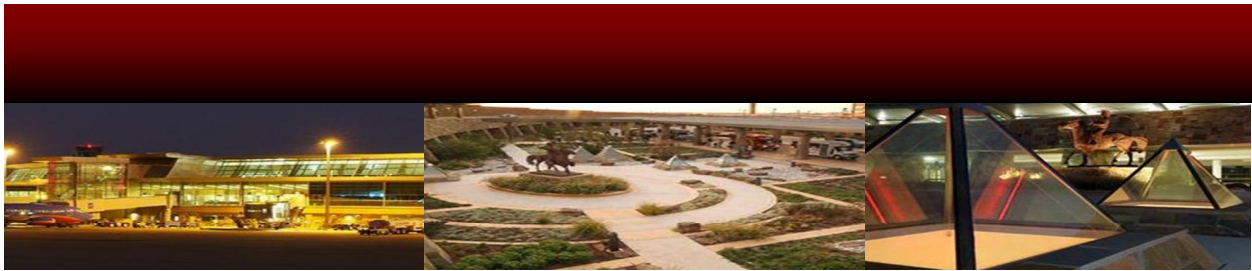
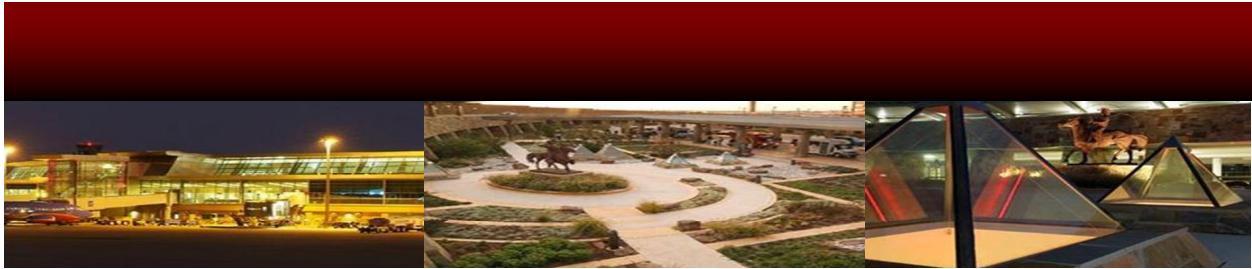

**Exhibit 4.1: Property Access and Landscaping**

### **4.1.2 Functional Placement**

Certain business functions have aesthetically negative characteristics that are best located where they have little visual or audible effect. In certain instances, it is necessary to locate these functions where the maneuverability of special vehicles can be better addressed.

In the case of utility type features (transformers, meters, valves, trash receptacles, etc.), care shall be taken to place these features to minimize the view from the public roadway. Features shall be screened with landscaping, berms, or screening walls as illustrated in Exhibit 4.1.



### 4.1.3 Building Orientation

In order to establish and maintain a sense of common quality, all land parcels will be developed to relate to the right-of-way frontage in a manner that implies a “sense of arrival” or a front door. The primary entrance or front of any building shall face the roadway upon which the parcel is located. Double frontage sites, in particular sites with frontage upon Interstate Highway 44 and Portland Avenue, will be required to have two front yard setbacks.

The impacts of orientation should be explored and evaluated during the conceptual stage of the project. A 360-degree view should be studied. Building orientations must be sensitive to adjacent sites and developments and their need to maintain views. Considerations must also be given to the views onto the site and off the site.

## 4.2 Screening

Screening by means of permanent walls of masonry construction or live plantings as part of the landscape scheme is an important tool in the successful planning of site functions. Screening may also be achieved through proximity to buildings.

Permanent screening walls shall be constructed of materials compatible with the construction of the building. Where storage is higher than six feet, the screening wall shall be designed and constructed to be of the same height as the stored material where possible. Permanent screening walls for these areas shall not be placed outside a paving setback line.

Where required by WRWA, parking areas shall be screened from adjacent property with continuous berms along the length of the parking areas. The combined height of parking screening, berms and plantings that face adjacent property lines, shall maintain a 4 feet (4') minimum as depicted in Exhibit 4.2.

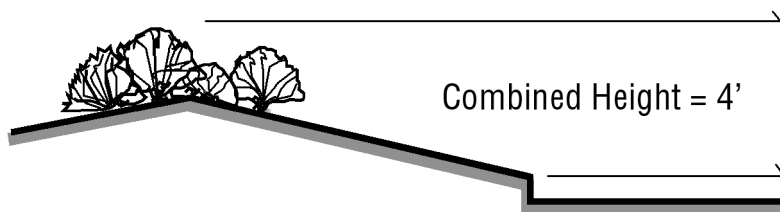

Exhibit 4.2: Screening

## 4.3 Setbacks

Setbacks are provided to ensure appropriate placement of buildings and structures upon the proposed site. Development in setback areas may include driveways, directional signs, sidewalks, other walkways and parking. The primary use of setback areas is intended for the planting and growing of trees, shrubs, lawns and other ground cover.



The setbacks are measured from the leasehold boundary of the site. All setbacks require airport approval.

### **4.3.1 Landscape and Setbacks**

Front, rear and side setbacks are defined as the distance from a building to a leasehold boundary. No building shall be constructed within the setback areas. Structures may have a smaller footprint than the setback limits and may be set back further from the lease line than the setback lines would otherwise require.

A paving setback is defined as the distance from a leasehold boundary to any paved area such as parking.

Development within the setbacks are restricted to landscaping and limited improvements such as structures below ground, driveways, sidewalks, pedestrian plazas, underground utilities, site screening walls, fencing, and retaining walls integral to landscape design or site contour engineering and signage. If landscaping is not properly maintained by the tenant, the Airport may undertake such maintenance as it deems necessary with the expense therefore borne by the tenant. The Airport shall solely determine whether the tenant's landscape maintenance is proper.

### **4.3.2 Front Setbacks**

Each land area located adjacent to a roadway, future roadway or roadway right-of-way shall be designated a front yard. Setbacks from the front yard lot lines shall be a minimum of thirty-five feet (35') from the lease line. Additionally, buildings exceeding a height of thirty-five feet (35') shall provide an additional one foot of front setback for every foot of height above thirty-five feet (35').

Sites that front on the intersection shall incorporate the required setbacks of each roadway as shown in Exhibit 4.3. Such a project site would typically not have a rear yard, but will have two frontage setbacks and two side yard setbacks on a typical rectangular site.

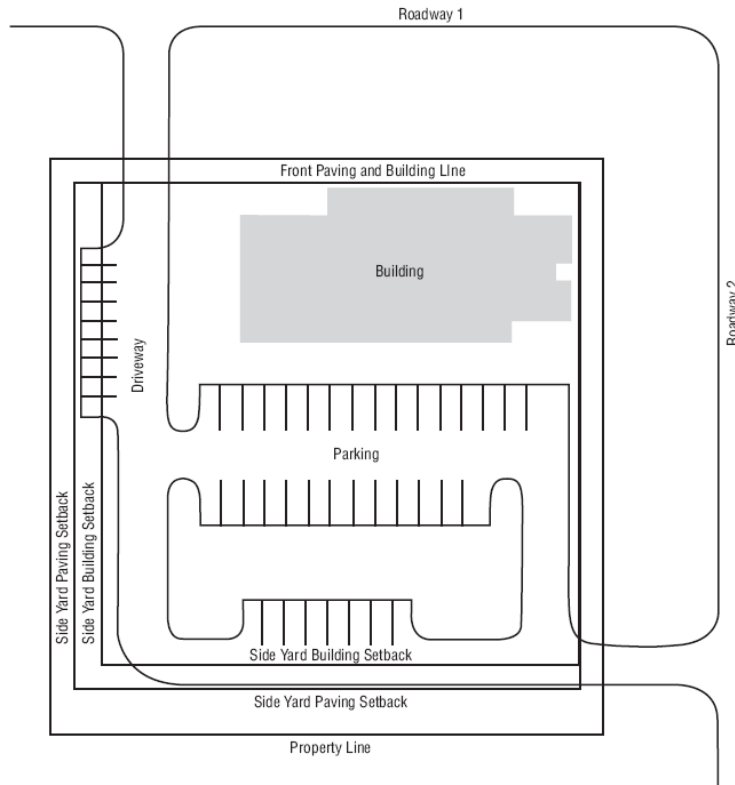

**Exhibit 4.3: Front Setback**

### **4.3.3 Side Setbacks**

Side setbacks shall be a minimum of fifteen feet (15') from the leasehold boundary. Additionally, buildings exceeding a height of thirty-five feet (35') shall provide an additional one foot of side yard setback for every foot of height above thirty-five feet.

### **4.3.4 Rear Setbacks**

Rear setbacks shall be twenty feet (20') from the leasehold boundary.

### **4.3.5 Paving Setbacks**

Paving setbacks shall be 10 feet (10') from the leasehold boundary except at the point of ingress and egress.

### **4.3.6 Building Restriction Line**

No building, structure, or vehicular parking shall be located between the building restriction line (BRL) as established by the current Will Rogers World Airport Layout Plan and the centerline of a runway.





Setbacks from any taxiway shall be in accordance with Federal Aviation Administration (FAA) standards as defined in AC 150/5300-13 "Airport Design".

### **4.3.7 Exclusion from Setback Requirements**

The following structures or improvements are excluded from the setback requirements:

- Roof overhang
- Steps and walks
- Paving and associated curbing in compliance with Section 4.3.5
- Fences
- Landscaping
- Planters, not over four feet in height
- Approved signs identifying the tenant

## **4.4 Site Coverage**

Building site coverage requirements will vary by land use and shall be evaluated for each development type. The maximum area of each site to be built upon shall not exceed 50%, unless otherwise approved by WRWA. Building site coverage is defined to be the percentage of the site covered by the primary building and all other ancillary above ground structures on the site. Above ground ancillary structures may be such things as fuel farms, pump houses, trash compactor enclosures and similar appurtenances. Building site coverage does not include those elements described in Section 4.3 Setbacks.

Additional provisions shall be made to accommodate all parking and circulation, storage, and mechanical equipment within the setbacks without sacrifice of the landscape features prescribed in Section 4.11 Landscaping.

## **4.5 Building Heights**

All structure heights shall conform to the rules and regulations of the Airport and the Federal Aviation Administration. Height limits are based on above mean sea level elevations to protect arriving and departing aircraft and to encourage and promote compatible development within the range of terminal navigational aids and radar. No structure will be erected or modified that will block sight lines from the air traffic control tower cab to any part of the runways or taxiways. Building height includes mechanical penthouses, antennas, heating and cooling towers and equipment.

The FAA has established Federal Aviation Regulation 49 CFR Part 77 that establishes standards and notification requirements for objects affecting navigable airspace. All applicants must comply with the Federal Aviation Regulations (FAR) Part 77. Applicants shall submit all information required to complete



Form 7460-1 to the Director of Airports who shall in turn submit the information to the FAA. The FAA approval process is typically 90 days.

A copy of FAR 77 can be obtained from the FAA website:

[www.faa.gov/airports\\_airtraffic/airports/regional\\_guidance/central/construction/part77/](http://www.faa.gov/airports_airtraffic/airports/regional_guidance/central/construction/part77/)

## 4.6 Building Exterior Design Requirements

The Airport's goal is that these Standards guide the development at the Airport, so that it aesthetically enhances the appearance of the Airport.

To ensure architectural consistency in the design of all Buildings and Improvements constructed at the Airport, the following basic architectural vocabulary shall be followed:

- All buildings shall be designed in such a manner that roofing materials and elements on the roof are not visible from 10 feet (10') above ground level. A strong horizontal fascia band, either at the face of an overhang or flush with walls or pilaster faces below, shall be used. All overhangs shall have a soffit.
- Roofs should be attractively designed and constructed. Written approval from the Airport must be obtained prior to the placement or painting of any signs, letters, designs or other graphics on a Building's roof. Materials used for roofs shall have a non-glare surface.
- Below and within fascia bands, solid walls, columns, pilasters, fins, etc. windows, and storefront assemblies shall be designed in an orderly, uniform pattern with uniform widths, sills, and head heights.
- Roof-mounted air conditioning units, exhaust fans, etc., shall be located away from the edges of the Building. All units shall be screened from view from 10 feet (10') above ground level with an architecturally compatible screen.
- Accessory buildings, enclosures, and fences shall be of materials compatible with the buildings they adjoin.
- The exterior materials allowed for use in Section 10: Architectural Materials shall be used with consistency in each design, i.e., the wall material selected is to be used for all of the walls and the fascia material selected used for all fascias.
- Where two occupancies, such as a hangar or warehouse and an office building, are a part of a single design, two of the allowable finishes shall be used as appropriate.

## 4.7 Building and Construction Materials

All buildings materials used shall be subject to Approval and must comply with the design standards established in this document as specified in Section 10.



## 4.8 Aircraft Parking, Servicing and Taxiways

### A. Taxiways and Aircraft Parking

All aircraft taxiways and parking areas on the building/lease site shall be paved with Portland Cement Concrete of sufficient strength to accommodate the heaviest vehicle anticipated to be parked on the building site, or sufficient strength to accommodate aircraft with gross ramp weights of at least 45,000 lbs. whichever is greater.

Any connection from a taxiway or apron on a parcel to a paved surface of an abutting public use taxiway shall be either (1) extended 100 feet into the parcel from the connection, of the appropriate material and load-bearing strength in correlation with the design aircraft or (2) painted and identified by signs in accordance with standards established by the Airport to indicated load-bearing limits of the connection.

### B. Aircraft Servicing

Except for permitted parking of aircraft on designated areas of the Airport, provisions for parking aircraft belonging to tenants and their patrons, invitees, employees, and others shall be on the building site.

Whenever hangar doors open onto a lease property line abutting a taxiway, they shall be set back a distance which in the opinion of the Airport shall provide sufficient clearance (in no event less than 25' from the hangar) for the holding, maneuvering, and parking of aircraft. No holding, maneuvering, stopping or parking of aircraft off a building site for purposes of hangaring, parking or storing of aircraft shall be permitted.

All aircraft parked or left unattended on any building site shall be entirely within the lease boundary lines.

## 4.9 Aircraft Engine Exhaust Restrictions

Tenants that operate turbine engine aircraft or have visitors or patrons that operate turbine engine aircraft shall limit the circulation and/or operation of said aircraft or otherwise install permanent blast deflection or blast mitigation devices in a manner or design that will limit the resulting exhaust air velocities to no greater than 30 miles per hour as measured at any point where pedestrians are permitted or where aircraft weighing less than 12,500 pounds are permitted, or at a Lease Boundary Line adjoining another Parcel.

Estimates published by aircraft manufacturers for engine exhaust air velocities shall be used in planning said operating procedures and protective devices and at the sole discretion of the Airport shall be further augmented with monitored field tests of actual aircraft operations. The results of these field tests shall be submitted to the Airport prior to the Airport's Approval of said procedures and/or device designs.

## 4.10 Noise Exposure

Facilities within the Airport may be subjected to average noise exposure from airport operations in excess of 65dB. Activities that are sensitive to excessive noise are discouraged within these areas and structures



accommodating noise-sensitive uses must be sound and insulated to reduce interior noise in accordance with the applicable codes and standards.

## 4.11 Landscaping

### A. Design Philosophy

The Airport encourages a landscape concept designed to emulate or recreate natural prairies using native Oklahoma plants that are drought tolerant reducing both water consumption and maintenance. Landscaping should be consistent in design and density on all sides of the WRWA Commercial Land Development area. Maintenance of landscaping or streetscapes in right-of-ways (ROW) shall be as addressed in tenant leases. Tenants may enhance the ROW landscaping at visitor driveway(s) but are required to transition back to the baseline planting within 100 feet each way. Such enhanced areas will then be the responsibility of the tenant to maintain. Tenant landscape design shall provide smooth transition and continuation of existing landscaping in the setbacks and from existing adjacent properties.

Where driveways intersect public roadways or roadway intersections occur a visibility triangle complying with American Association of State Highway and Transportation Officials (AASHTO) shall be provided whereby landscaping, retaining walls and signage shall not infringe upon the ability of vehicle operators to see approaching vehicles from either roadway or driveway as illustrated in Exhibit 4.4.

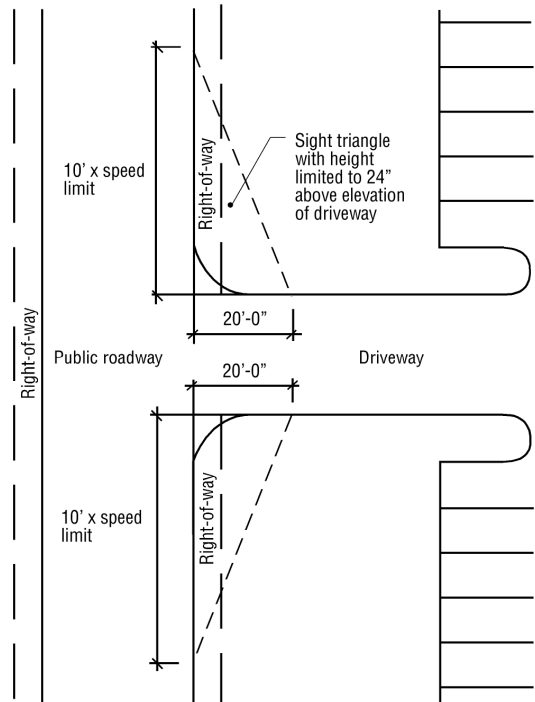

**Exhibit 4.4: Site Lines**

All landscaping needs to meet the requirements of the City of Oklahoma City landscaping ordinance.

### B. General Provisions

All site plans shall include significant landscape features and materials that are prescribed in the Development Standards Manual to (1) enhance the Airport's image, (2) help conserve water, (3) promote natural vegetation, (4) protect environmental conditions and microclimate, (5) improve the appearance and value of the property and (6) buffer land uses or buildings that differ significantly in scale or type.

The development of the site must contain specifications and details illustrating the scheme of the landscape development for the project in the construction documents. This scheme will take into account and prescribe all new plant materials (type, size and location), and irrigation plans. Plans, specifications, and inspections for landscaping are to be prepared and completed by a professional Landscape Architect

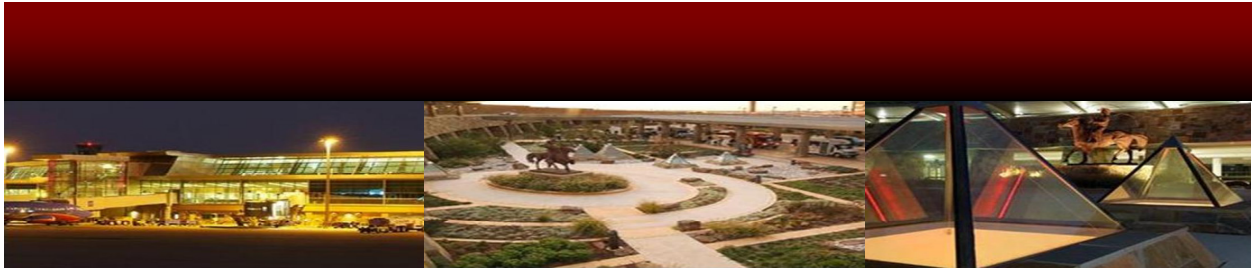

or designer. Landscaping, subject to approval, shall be installed within 60 days after the notice of completion of the building or as soon as weather permits. Irrigation shall be provided and operated by the tenant to serve all landscaped areas whose design requires said irrigation to maintain a healthy growth during normal seasonal growth periods.

All landscaping shall be maintained in an attractive manner and weed control applied at appropriate times. Plants and shrubs shall be maintained in a healthy, disease free condition. Dirt, litter and debris shall not be allowed to accumulate, particularly in areas covered with gravel, bark, rocks, or wood chips. Landscaping in all parts of the development site shall be continuously maintained to insure an orderly, attractive appearance and to meet specific requirements defined in the City's Landscape Ordinance.

All areas not paved or covered by Buildings shall be landscaped, in accordance with the Airport's Development Standards Manual. In addition to trees, ground cover and gardens, Landscaping shall include, where appropriate, the use of walls, screenings, terraces, fountains, pools, and other water arrangements.

Plans, specifications, and inspection for Landscaping shall be accomplished by a professional Landscape Architect or Designer registered in the State of Oklahoma and shall require written approval of the Airport prior to installation. Said plans shall indicate maximum tree heights of mature trees.

Plant materials shall be of the highest grade and quality as defined by published authoritative standards applicable to the State of Oklahoma, City of Oklahoma City and the Airport location. Wherever possible, plant material should be indigenous to Oklahoma.

A continuous Landscaping strip shall be required to be installed and maintained on all Parcels abutting all roadways. Any area between the Lease Line and the nearest edge of the pavement or curb of the abutting roadway shall also be landscaped by the tenant and maintained by the tenant to the satisfaction of the Airport. The Airport, at its sole discretion, may alternatively elect to maintain a portion or all of said Landscaping on any or all Parcels, and shall charge tenants a fee for said services. The criteria, specifications, and standards for the design of this Landscaping shall conform in appearance and quality with the overall Airport Landscaping Guidelines. Tenants on Parcels abutting Roadway rights-of-way that are not improved when the Parcel is occupied shall be required to meet the same Landscaping requirements at such time as the unimproved portions of abutting Roadways are improved and completed.

### **C. Tree Sizes/Mix**

The minimum size of trees and shrubs are to be as follows:

- Deciduous trees – three inch (3") caliper;
- Coniferous trees – eight foot (8') height;
- Shrubs – two feet (2') height or spread.

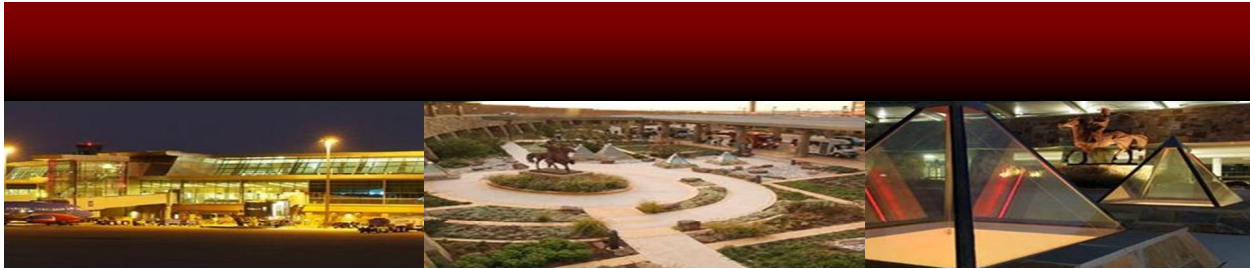

#### **D. Plant Materials**

All plant materials are to be of a species capable of healthy growth in the local area. Trees and shrubs are not to be the types which will attract birds or provide them with feed.

#### **E. Design**

It is suggested that planting be in groups whenever possible. Shrub beds are to contain low maintenance mulch. Plantings are to be designed not to impede vehicle sight lines.

#### **F. Grass/Sod/Seed**

All sites are to have properly maintained turf grass (6" in height or lower) along the front of each site between the road right-of-way and the building and/or parking area. Seeded areas are to have a minimum of four inch (4") depth topsoil. Sodded areas are to have a minimum of three inch (3") depth topsoil. All seeded and sodded areas are to be established as soon as possible after completion of building construction. Unimproved areas set aside for expansion are to be seeded at minimum and maintained as part of the overall site and shall be the type of grass that doesn't attract birds or wildlife.

#### **G. Berms**

Berms, used for screening purposes, are to be a minimum of three feet in height (3') and are to be landscaped with trees and/or shrubs and grass. Berm design is subject to utility clearances and drainage requirements.

#### **H. Retaining Walls**

If retaining walls are required, the wall material is to be constructed of cast-in-place concrete, brick, precast concrete units, sandblasted and rusticated joint concrete, concrete masonry unit systems or stone. Timber retaining walls are not permitted. Retaining walls of more than two to six feet (2'-6') in height are to be terraced so that each lift is not greater than two to six feet (2'-6').

#### **I. Maintenance**

All landscaping is to be designed for reasonable maintenance and all landscaped areas shall be maintained in a quality, well-manicured manner at all times and is the sole responsibility of the lease holder. Diseased or damaged trees, shrubs, groundcover shall be replaced to a condition which satisfied the original approval of the development plans. Likewise, the irrigation system is to be maintained in an operative state. Leaks and broken heads shall be repaired immediately in order to perform as required and maintain natural resources. Automatically controlled irrigation system shall be equipped with rain sensors to prohibit the operation of the system during rain. In addition, a temperature-limiting thermostat shall prohibit an irrigation system from operating when outdoor temperature falls below 34. Low water (drip) systems are strongly encouraged to reduce water consumption. The Airport may undertake such maintenance at its sole discretion as it deems necessary with the resulting expense charged to the tenant.



## **J. Plant Material**

Plant selections should promote a sense of variety and provide landscape solutions consistent with typical Oklahoma landforms. In no case should a monoculture of neither a single plant selection nor any single selection dominate the site.

A planting strip will be provided along all lease lines where parking areas are adjacent to or fronting a publicly accessible street. No artificial trees, shrubs, turf or plants may be used to fulfill the landscape requirements. All landscape materials shall be placed in accordance with standards that support the continued good health of the plant materials. In addition, the following ratios should be observed when establishing minimum quantities of plants required within the boundaries of the lease unless otherwise approved by the Airport. Trees: 12 per acre of leased area, subject to approval by WRWA.

Trees: 50% minimum shall be multiple trunk plants Shrubs: Minimum of 25% of the total landscaped area shall be shrub or ground cover beds. Groundcovers: All other areas that are not paved or shrub beds shall be turf grass to a maximum of 75% of the landscaped area.

## **K. Irrigation**

All areas of live material over two hundred (200) sq. ft. shall be irrigated. All required landscaping shall be maintained in good condition, and all required landscaping that dies or becomes diseased or decayed shall be promptly replaced.

### **4.12 Parking**

#### **A. Parking Design Philosophy**

Parking areas shall be designed to create the smallest visual impact upon the site affecting the efficiency of land without affect on the efficiency of land use. This goal should be achieved by the subdivision of the parking and circulation requirements into smaller zones or modules each of which is visually softened and buffered from other modules by the weaving of naturalized landscape design elements through the total site area.

The total parking requirements of a site shall be subdivided into modules of no more than 30,000 sq. ft. Each such module should be separated from other such modules, connecting driveways, public rights-of-way and building walls by a landscaped margin no smaller than twenty feet (20') in width. Where pedestrian routes occur, the paths or walks shall be reinforced concrete, brick or concrete pavers. These landscape margins and pedestrian ways shall be covered by elements of the site lighting systems in order to enhance the nighttime effect of the landscape scheme and to provide security and safety for the use of the pedestrian ways.

The landscape margins shall be elevated by means of berm construction with an average elevation of at least eighteen inches (18") above the curb bordering the adjacent parking area. The landscape elements placed within these margins should represent a mix of plants, palette selected for the site rather that a



single selection used repeatedly through the parking areas. These margins shall be provided with adequate irrigation to maintain the planting masses (Exhibit 4.5).

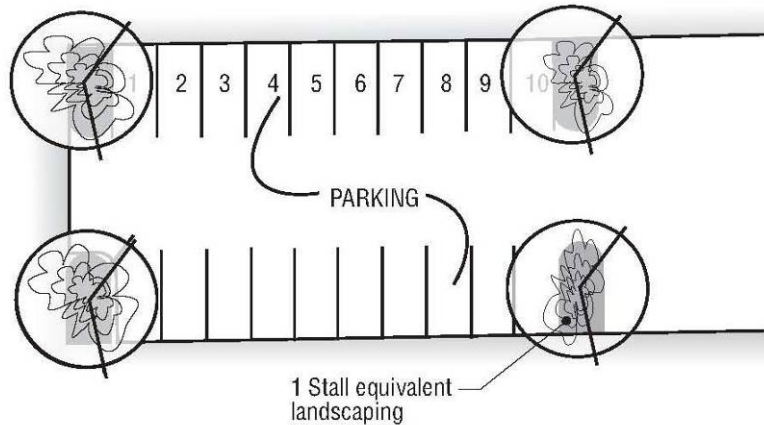

**Exhibit 4.5: Parking Layout**

## B. General Requirements

Vehicular entrances and exits, as well as traffic routes, shall be located and designated in a manner that provides a clearly defined, safe, efficient and convenient circulation pattern for both on-site vehicular and pedestrian movements.

Parking shall not be permitted on the public streets and between the street pavement and property line. Employee parking shall not be permitted between the front of the building and public streets, but shall be located on the side or back of the building. Public and visitor parking can be located in front of the building. All parking shall be screened from view of the right-of-way by the use of approved berms, trees, or shrubbery specified in the Development Standards Manual, or such screening as may be approved via review and approval of a site plan by the Director of Airports.

All parking lots, drives and roadways shall be of sufficient strength to accommodate intended use, but shall not be less than 6,000 pound gross vehicle weight for areas to be used by automobiles and 20,000 pound load per axle for areas to be used by trucks.

## C. Minimum Parking Requirements

Parking areas shall be sufficient to accommodate all parking and vehicular circulation needs for employees, overlapping shifts, company vehicles and visitors without the use of on-street parking shall be provided by the tenant. Tenants shall advise the Airport in writing of any change or intensification of use



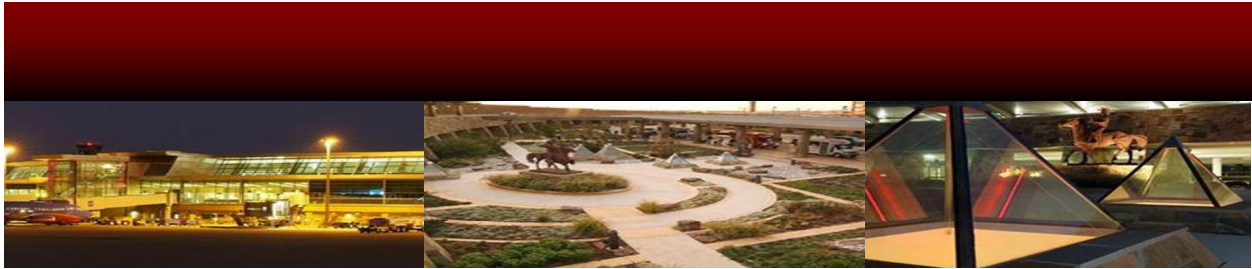

that will increase the number of number of vehicles accessing the site. It is incumbent upon the lease holder to access and incorporate the parking and vehicular access needs generated by the intended use of the site. It shall be the responsibility of the lease holder to provide for the complete and total parking and circulation needs as the project is developed and constructed. Eventual increased requirements in parking a circulation shall be specifically addressed and implemented before the need is actualized. All vehicle staging, queuing parking, loading and unloading shall only be permitted within the boundaries of the tenant's leased area. The use of off-site staging, queuing, parking, loading and unloading to provide for any complement of the parking requirements is specifically forbidden.

For each development proposal, a parking study is to be completed by the tenant to demonstrate the parking proposal is sufficient for the uses/activities proposed for the site. This study is to include current parking requirements, future expansion plans, details regarding types of businesses onsite, etc.

*Minimum Parking Capacity Guidelines:*

The following shall be considered a minimum level of parking spaces for each type of facility:

a. Manufacturing or Industrial:

Office space: one space per each 200 sq.ft.

Hangar/Manufacturing space: three spaces per 500 sq.ft.

Warehouse space: one space per 1,000 sq.ft.

b. Office and Professional:

Professional and Administrative Office: one space per 200 sq.ft.

Financial, Institutional and Technical Research: one space per 200 sq.ft.

Medical and Health Services: one space per 175 sq.ft.

Call Centers: one space per 200 sq.ft.

In addition, provide 1 space for every 7 employee space for visitors to a maximum of 5 spaces of parking of ½ day maximum duration. Facilities in the business of charter and corporate flight services are to provide visitor parking spaces equal to the seating capacity of the aircraft stored on site or provide a detailed parking study to demonstrate that sufficient on-site parking (i.e., leased parking lot) is provided. On-street parking will not be permitted. Parking spaces for the office staff and visitors are to be located forward for the shop/hangar's front wall. Visitor spaces are to be clearly designated on site as visitor's parking.

The minimum parking space size is eight feet six inches (8'6") by eighteen feet (18') otherwise provided in the City of Oklahoma City Zoning Code for off-street parking. Consult federal, state and local ordinances regarding the provision of parking for the physically disabled. Specific markings shall be applied to paving surfaces depicting emergency or specific regulatory zones shall be delineated on all project documents describing the paving and parking plan. Provide one (1) parking space for each truck and service vehicle to be stored on site. The space(s) must be designated and located behind the front wall of the shop/hangar.



### C. Parking Layout

All parking areas shall be designated and landscaped to eliminate the monotony of large single-paved areas. Parking in the front setback area shall not exceed 50 percent of the required minimum front building setback area, and shall be appropriately screened from view by landscaping.

### D. Paving Materials

At minimum, parking areas, driveways, loading areas and aprons shall be paved with asphalt or concrete with integral concrete curb and gutter. Gravel parking surfaces will not be permitted. All paved surfaces are to be regularly maintained and kept in good repair. Each parking space shall be designated by lines painted on the paved surface – white or yellow depending on the paving material.

### E. Loading & Maneuvering Areas

Loading bays shall be located in such a manner as not to impede the safe and efficient flow of traffic and to minimize impacts on adjacent tenants. Loading docks and doors are to face into either the side yards or rear yards. Loading docks within 100 feet of the front wall of the building are to be completely screened from view from the street. The screening is to be achieved using the building site layout or solid wall and/or fencing compatible with the building's cladding materials.

For the Aviation and Aviation Support Development Area, loading docks and doors can face towards the public street in the case where a compelling functional reason can be demonstrated to the satisfaction of the Airport. For example, facilities where several aircraft are loaded or unloaded adjacent to or inside the hangar portions of the building, may also require some truck doors to face the street for obvious functional reasons (Exhibit 4.6).. If approved, all such design variances are considered "Designs of Merit". This possibility of exception does not apply to corner lots.

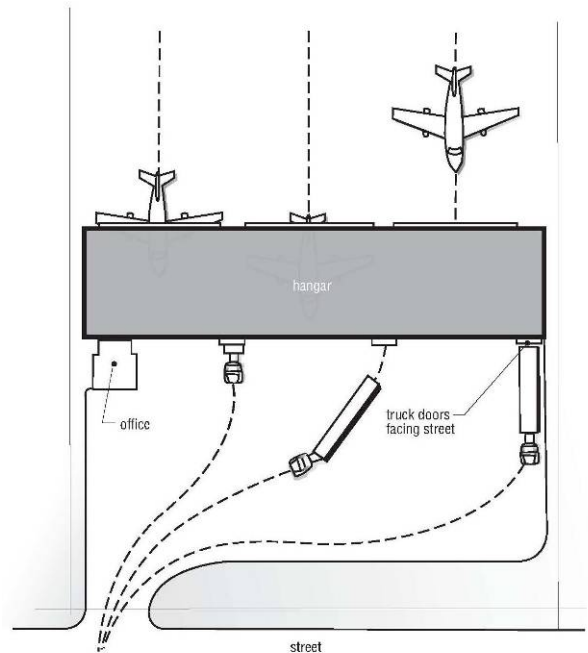

**Exhibit 4.6: Access & Loading/Maneuvering Area for Airside Development**

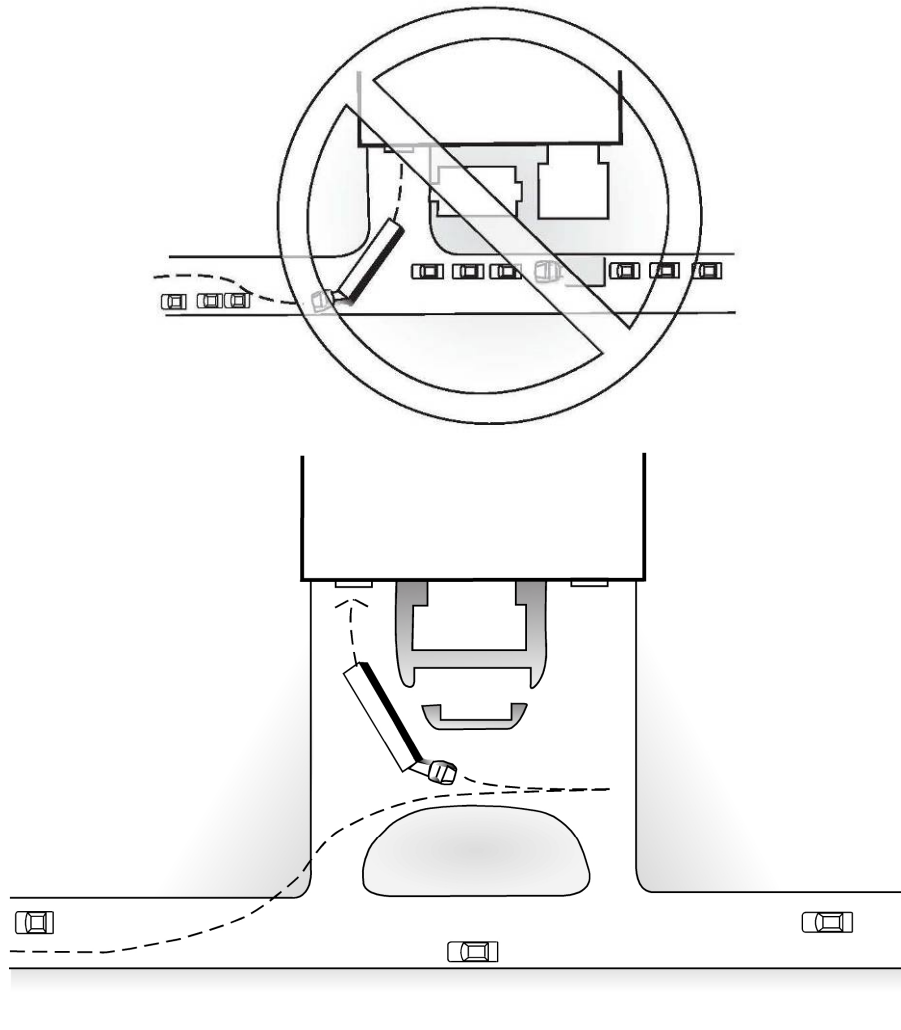

**Exhibit 4.7: Loading and Maneuvering Areas**

For the Nonaeronautical Development Area, the following guidelines apply:

- The number of overhead loading dock doors is limited to five;
- Loading dock doors can not face into either the front yard or the side yard flanking a street on all corner lots; and

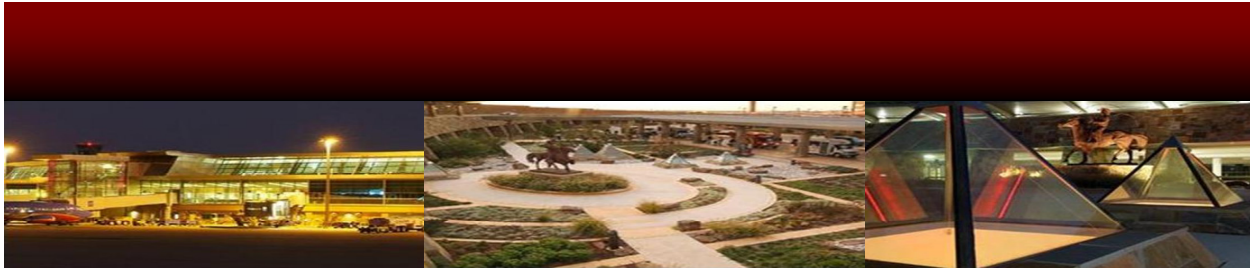

→ Exterior loading dock platforms are not permitted.

All vehicle turning movements for loading must occur within the site boundaries. No vehicle turning movements will be allowed on the streets.

## 4.13 Signage/Graphics

### A. General Requirements

Signage and graphics within WRWA is intended to be integral with overall architectural development. All signage within airport limits up to the site of a proposed facility shall be provided by the Airport. Private signage will be allowed on the face of buildings to the extent that they are appropriate and meet Airport standards. The Airport shall approve all signage prior to fabrication and installation.

Corporate logo signage will be allowed only adjacent to the main tenant or public entry into the building. It must be securely mounted to the side of the building with the size subject to approval by the Airport. Any illumination of the sign must be internal to the sign body. The sign must be located to not create adverse conditions of glare or blocked views.

All signage installation requires a permit through the City of Oklahoma City

### B. Signage/Graphics

Any wall planes higher than twenty feet (20') shall be visually broken up into wall areas which are no greater than fifteen feet (15') high. Architectural devices for achieving this requirement are: changes in materials, changes in material profiles and massing, changes in material colors, accent banding, strip windows and/or a graphic package. The use of other creative architectural devices to create visual interest is also encouraged. Signs shall be restricted to tenant identification only, either wall mounted or free-standing.

### C. Building-Mounted Signage

All building mounted signage should identify individual occupant names only. Occupant typefaces or logos may be used, subject to WRWA approval. Individual letters should project not more than eighteen inches (18") from the wall they are mounted. Building signage may be backlit in the form of individual letters or opaque background cabinet type signs. Area of exposed signage per elevation should not exceed one square foot per lineal foot of building frontage. Height of sign on building face shall not be higher than the building height.

### D. Single Occupancy Facilities

Only one primary occupant sign is allowed per building. The sign height shall not exceed twenty percent of the facade height and the sign area may not exceed 150 square feet, measured as a rectangle placed around the extreme edges of the sign, or letters. One identification sign - a pedestal or monument sign located within twenty five feet (25') of the main entrance road into the site and just inside the front yard



setback - is required. The monument sign is to be no more than 3 feet (3') high. Signs in other location are optional:

- A sign can be located on the shop walls. The shop wall sign is to be between 4 feet (4') and eight (8') feet high.
- A sign can be incorporated into the design of the public front entrance. The public entrance sign letters are to be a maximum of 2 feet (2') high. For this particular sign, the logo or other signage related graphic may be larger if properly designed as a design of merit.

### **E. Multi-Occupancy Facilities**

Secondary or multi-tenant signage area may not exceed 20 square feet, measured as a rectangle placed around the extreme edges of the sign or letters. Multi-tenants shall be consistently signed. For multi-occupancy facilities with common office entrances, two tenant identification signs are required. One sign is to be located on the shop wall directly above the vehicle loading doors. The second sign is to be integrated into a single common pedestal sign for all tenants located within twenty five feet (25') of the main entrance road and just inside the front yard setback.

For multi-occupancy facilities with individual building entrances, two tenant identification signs are required. One sign can be located either on the shop wall directly above the vehicle loading doors or over the main door entrance but not both. The second sign is to be integrated into a single common monument sign for all tenants located within twenty five feet (25') of the main entrance road and just inside the front yard setback. No individual tenant identification is permitted at the front entrance apart from an internally located office directory. The shop wall sign is to be a maximum of 2 feet (2') in height. The public entrance sign letters are to be a maximum of one foot (1') in height unless it can be demonstrated to be a Design of Merit.

### **F. Monument Signs**

A two-sided monument sign that complies with the design criteria should be located in the front yard perpendicular to the road. It shall not be located in the road right-of-way. Responsibility for the sign shall remain with the lease holder. One monument sign per public entrance will be allowed, unless otherwise approved by the Airport. Monument signs may not exceed 3 feet in height and may be backlit, unless otherwise approved by the Airport. Size is drawn from the linear building frontage from which the elevation is on, and area subtracted from allowed wall signage. Monument signs may be no closer than 25 feet to adjacent roadway pavement as illustrated in Exhibit 4.8. Secondary signage may be allowed as monument sign. Surrounding the sign structure should be an eighteen inch minimum of planting bed of short native grasses or ground cover.

### **G. Site Information/Directional Signage.**

Should be consistent with the architectural design of the building and the monument sign. Directional signage shall be limited to 6 square feet, 4 feet overall height maximum and shall not extend to ground. Text shall be located above 24 inches from ground. Signs shall be located within the lease boundaries.



Regulatory signage shall be limited to 2 square feet, 8'-6" overall height maximum. Flashing, blinking, animated, audio, or moving signs are not permitted. Backlit illuminated awning signage is not permitted.

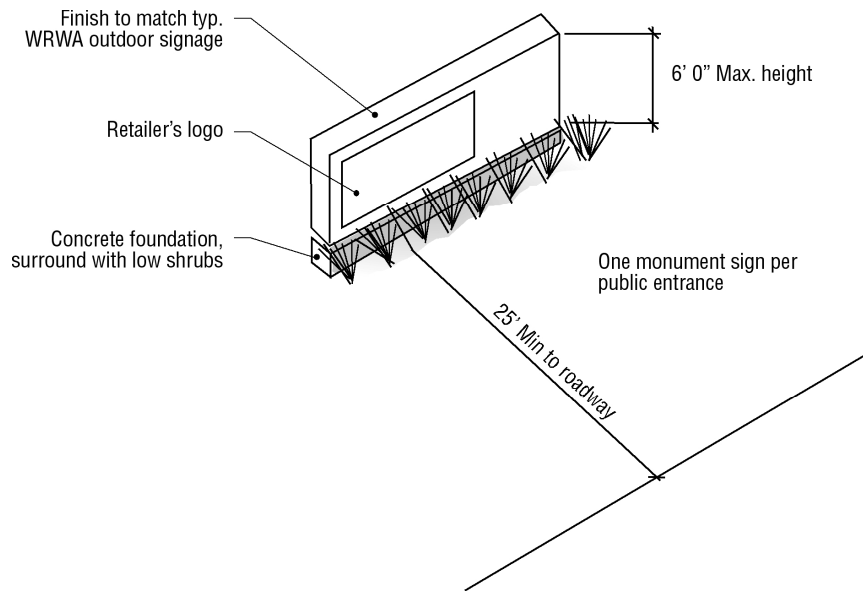

**Exhibit 4.8: Monument Sign**

## H. General Requirements

- ➔ The identification pedestal sign is to include the Company's name, logo and address for single occupancy. Only the company's name is required on multi-occupancy pedestal identification signs.
- ➔ The public entrance identification signage is to be individual back-lit letters and logo which cannot project more than fifteen inches (15") from the building wall.
- ➔ Neither rooftop signs nor signs extending above the parapet walls are permitted.
- ➔ Signs are not permitted which allow escape of any unfiltered light. No signs or any other contrivance shall be devised or constructed to rotate, gyrate, blink, move or appear to move in any fashion.
- ➔ No signage shall be attached to the interior or exterior of the glass. No advertising or other promotional signage contrivances are permitted.



- ➔ Freestanding directional signage is to be a monument sign design only to a maximum of 6 feet (6') in height. It is to be in the same architectural design and style as the monument sign including back lit letters. Building directional signage is to be designed as part of an integrated graphic package and is to be back lit similar to the identification signage. Directional signage shall be limited to 6 square feet, with text shall be located above 24 inches from ground. Signs shall be located within the lease boundaries. Regulatory signage shall be limited to 2 square feet, 8' overall height maximum. Flashing, blinking, animated, audio, or moving signs are not permitted. Backlit illuminated awning signage is prohibited.
- ➔ In terms of temporary signage, no mobile and/or rental signs are permitted. All temporary signs must have a designated expiration date. Such dates need to be documented in the project file. Typically 30 to 45 days is ample time to fabricate a permanent sign. Where warranted, expiration dates may be extended approximately the same number (or less) of the days originally approved. Temporary signs must be removed on or before their expiration date. Temporary construction signs are permitted but they must be removed within 30 days of substantial completion of the project. Only one "For Sale" or "For Lease" sign will be permitted.

## 4.14 Site Lighting

### A. General Design and Location

The objective of on-site lighting is to highlight landscaped areas, pedestrian circulation (walkways), buildings, identification signs, parking or approved storage for decorative or security reasons. Lighting shall be designed to avoid or minimize light diffusion to adjoining property where negative impacts may be created. The lighting shall complement and not dominate the design character of the site. Indirect wall lighting or "wall washing", overhead down lighting or interior illumination which spills outside is encouraged.

The design and location of exterior lighting is subject to the approval of WRWA and is to comply with the requirements of the FAA with respect to height, type and placement of lighting standards as they may affect the safety of flight operations into, from and around the airport.

Architectural lighting shall articulate and animate the particular building design as well as provide the required functional lighting for safety and clarity of pedestrian movement. Signage lighting is to be individually back lit letters and/or logos. Outrigger lighting is not permitted.

Although exterior security and feature lighting is not required, it is strongly recommended for safety and enhancement.

Utility service for lighting shall be provided underground. All exterior lighting shall be metal halide, incandescent, or high pressure sodium and any additional light sources are to have a white light appearance. All lighting shall reflect downward to avoid potential FAA conflicts due to the property's vicinity to aircraft operations. The use of energy efficient lighting is encouraged.



Service and/or storage lighting shall be contained within service and/or storage yard boundaries and enclosure walls. No light spillover should occur outside the service and/or storage area. The light source should not be visible from roadways.

Lighting of developed sites shall include provisions required to provide reasonable illuminations for access to and from buildings within the boundaries of a site. The design of each site scheme shall be included in the construction documents submitted for approval for each site and shall include layouts, mounting heights, fixture and lamp specifications and lighting design calculations in accordance with the Illuminating Engineering Society of North America.

### **B. Parking Areas and Driveways**

It is mandatory that lighting “spill over” and illuminate beyond the areas of need. In all automobile parking areas, the maximum foot-candle level acceptance at the ground plane is one foot candle, and the pole height is restricted to 35 feet in open paved areas. In no case should light fixtures spread light beams more than 45 degrees from perpendicular (90 degree cutoff angle). Lighting mounted on vertical wall planes that direct the light beam away from the building across a property line or up to the sky are forbidden. Site lighting shall be designed to provide uniform illumination throughout the site. Height shall be in compliance with FAA regulations. Structural pole shall be square steel or aluminum with silver gray finish (galvanized, anodized, and painted).

### **C. Pedestrian Lighting**

In cases where pedestrian ways cross the landscape outside of the coverage of parking lot lighting, it is recommended that short pole-mounted lighting (16 feet maximum height) or bollards (42 inches maximum height) be provided to allow the pedestrian five-foot candle of luminance at the ground plane. This level of luminance shall be restricted to an area no greater than five feet from the edge of the paved pedestrian way.

### **D. Landscape Lighting**

It is desirable to provide landscape illumination to enhance the visual appeal of the site 24 hours per day. Care should be taken to enhance the landscape’s natural qualities with lighting rather than to flood or spot light great vistas or specimens. The most desirable techniques for this purpose include:

The up lighting (limited) of trees from fixtures mounted below grade or at grade. These fixtures utilize mercury vapor or HID Lamps. Care should be exercised that these fixtures do not direct the beams of light beyond the tree structure below an angle of 75 degrees from the vertical.

The primary focus of site lighting should be the emphasis on the main entry to the building and the pathways leading to the entry. This emphasis should not be strictly limited to pathway lighting but should incorporate zones of landscape along this primary path from parking along pathways to the building entry.

### **E. Security Lighting**



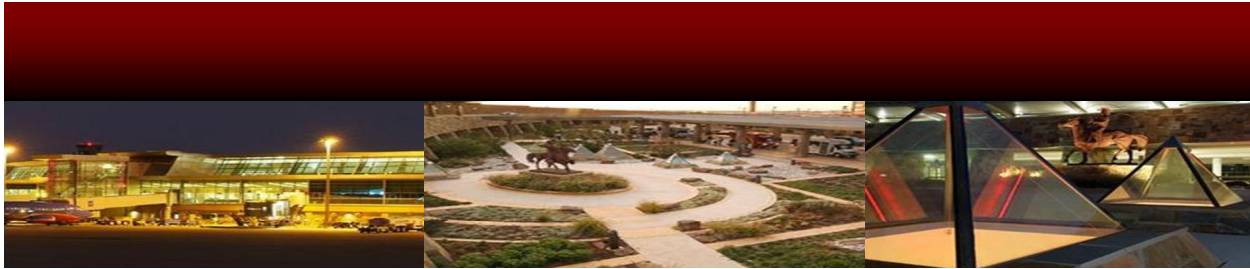

Where security or safety lighting is deemed necessary, it should be localized as much as possible to avoid floodlighting large areas. The design of the light source should be directed on the immediate area of security concern and whenever possible should be automatically triggered by sensors or remote control.

## **F. Lighting Controls**

The designer and engineer are urged to provide controls that automatically limit the hours of operations according to seasonal day night changes. In addition, it is desirable that these controls provide separation between the various types of site lighting so that unnecessary lighting components can be shut down at different times in order to conserve energy.

## **G. Unacceptable Lighting Techniques**

For the purpose of providing an aesthetically coordinated system, the following techniques should not be utilized, unless otherwise approved by the Airport:

- Wall pack light fixtures with a cut-off angle from the vertical of more than 22.5 degrees or that are mounted higher than 20 feet above grade.
- Colored flood lighting.
- Open globe street lighting fixtures without cut-off.
- Strobing or blinking sources.
- Incandescent lamps.

## **H. Fixtures**

Outdoor flood lighting is to be provided on the ramp area. It is to be located and arranged so that no direct rays of light are directed at adjoining properties or the FAA ATCT, or interfere with taxiing aircraft. All exterior free standing light fixtures are to be from the range of approved fixtures by the Airport. Architectural and/or landscape feature lighting is to be directed downward. No upward feature lighting is permitted. All exterior lighting shall be maintained at adequate levels of illumination. Broken or burned out elements shall be replaced properly.

# **4.15 Outside Storage**

## **A. General Requirements**

All outside storage and refuse areas shall be constructed and contained to eliminate odors, insects, dust, visual nuisances, and other similar nuisances.

No materials, supplies or equipment, including company-owned or company-operated vehicles, shall be stored in any area on a Lot except inside a closed building or behind an approved barrier completely screening such areas from view of adjoining lots and/or public streets.



Activities that involve the dismantling of aircraft or the storage of salvaged aircraft, aircraft engine, airframes, parts, or accessories shall comply with these Development Standards for storage. Aircraft stored on the Airport without a current airworthiness certificate (except for purposes of relicensing) may, at the discretion of the Airport, be declared salvage aircraft and shall thereupon be treated as salvage aircraft for the purposes hereof.

### **B. Outdoor Storage**

Exterior storage of aircraft and helicopters is permitted. No exterior storage of equipment or supplies is permitted. Temporary marshalling areas are permitted in the Aviation and Aviation Support area. All storage is to be incorporated into the principal building and/or accessory building. All accessory buildings which are constructed at the time of the principal building's construction or in the future are subject to approval by the Airport.

No temporary building structures or other temporary storage contrivances such as trailers, sea-can, etc., are permitted. Activities involving the dismantling of aircraft or the storage of salvaged aircraft, aircraft engines, air-frames, parts or accessories shall comply with the design guidelines. No aircraft may be stored at the Airport without a current airworthiness certificate except for purposes of relicensing.

### **C. Trash & Waste Disposal**

Each building, complex of buildings, or separate commercial business enterprise shall have a separate storage area for trash and waste items generated, manufactured, or acquired by such commercial activities. The sorting, handling, moving, storing, removing, and disposal of all such waste materials must be housed or screened in a manner approved by the Airport. Each kitchen, restaurant or flight kitchen facility shall contain a water-flushing garbage grinder disposal. All facilities and plans for the disposal of wastes other than by public sewage methods (such as shredding, compacting, incineration, or chemical dissolution) must be approved by the Airport.

All outdoor refuse containers shall be visually screened by masonry or other material compatible with building cladding, so as not to be visible from adjacent lots or sites, neighboring properties, or streets. No refuse collection areas shall be permitted between a street and the front of a building. Refuse collection areas shall be effectively designed to contain all refuse generated on-site and deposited between collections. Deposited refuse must not be visible from outside the refuse enclosure. Refuse collection areas must be so located upon the lot as to provide clear and convenient access for refuse deposition and collection, thereby minimizing wear and tear on driveways and streets. Refuse collection areas, screening details, and operational aspects of garbage collection shall be identified in the submitted plans.

### **D. Petroleum Fuel and Hazardous Waste Storage & Handling**

No aviation fuel shall be stored, except as approved by the Airport on any building site other than on aviation fuel storage areas reserved by the Airport for such use and in accordance with a valid written contract with WRWA.



Hazardous waste and dangerous goods are to be handled and stored in conformance with all applicable Federal, State and Municipal acts, guidelines, regulations and codes. All facilities and plans for the disposal, storage and handling of hazardous wastes must be approved by the Airport.

## 4.16 Utilities and Easements

All utilities shall be brought underground to the site and to the building(s). Above ground utility equipment, transformers, boxes, etc., must be screened from view with appropriate landscape material pursuant to the guidelines established by the utility provider(s) for allowing maintenance access with approval from WRWA.

Permits for easements shall be obtained from the Airport Trust for all utilities to be located on Airport property, including sanitary sewer, water, gas, electricity, telephone, and/or fiber optic telecommunications.

Removal, replacement or connection to airport facilities in connection with the construction of utilities shall be by an approved contractor and shall be in conformance with the Airport's specifications. Approval to perform any utility work shall be obtained from the Airport prior to the commencement of work.

Indemnification shall be given to the Airport for the tenant's use of the easement areas.

Some parcels have existing utility lines installed within the parcel boundaries. Tenants shall be solely responsible for determining the presence and location of existing utility lines on their respective parcels. In all cases where the tenant shall construct improvements above or adjacent to the existing utility lines, provision shall be made for the maintenance, repair and replacement of said utility lines by the party having the responsibility and right to do so without major disruption of said improvement. The Airport shall determine what would constitute a major disruption of an improvement on a parcel.

## 4.17 Vehicular Access

The expected on-site presence of transport trucks and trailers, bulk deliveries, waste handling, fuel trucks and other large service vehicles which require large maneuvering and parking areas shall mandate the adequate design of paved areas to enable the on-site handling of these functions without the use of public streets. Such areas shall be located and screened to conform to the following guidelines:

- a. Sites adjacent to any median-divided streets or highways in the public right-of-way: No loading or maneuvering area shall be allowed in the front facing such a right-of-way and all such areas shall be located at the side or rear of a facility. In those cases where the area is placed to the side, such areas shall be screened with a landscape screen or permanent wall. No loading door shall be closer than 100 feet to the nearest right-of-way line.
- b. Sites adjacent to non-divided streets in the public right-of-way: Loading and maneuvering areas shall be allowed on all sides of a building with the following provisions: All such areas fronting on any roadway shall be screened. No loading door shall be closer than 100 feet from the building setbacks of the site.



## 4.18 Hedges and Fences

### A. General Requirements

Mechanical systems, maintenance facilities, trash containers, processing equipment and storage tanks shall be housed in an unclosed building or otherwise screened from public view in a manner architecturally compatible with the building and approved by the Airport. All screening and fencing improvements require a permit through the City of Oklahoma City. Such screening/fencing shall be of solid material similar to the exterior building cladding materials.

### B. Fencing

Fences are permitted only where approved by the Airport. Fencing is to be black PVC covered chain link fencing, wrought-iron, concrete or masonry or other solid fences similar to the building cladding materials, as approved by the Airport. Non-PVC coated chain link or wooden fences are not permitted. The mounting of signs other than the required posted signage on fences for the Airport lands is not permitted.

### C. Security Fences

Fences shall be constructed and installed to restrict access from the street to all restricted aircraft operations areas. Access to airside areas must be provided within the building site and unless otherwise approved, the access must be through the building. The design and placement of these fences and gates shall be subject to the written approval of the Airport. All gates must be locked at all times.

Chainlink fences for security perimeter fencing shall conform to WRWA standards and be 8' overall in height, with a 12" barbed wire overhang.

### D. Roof Objects and Appurtenances

All roof objects including mechanical systems, cooling towers, fans, air conditioners, vents and all other structures or roof mounted equipment which rise above the roofline shall be screened from view or all sides by a roof-mounted screen at least equal in height to the items being screened. Parapet walls can be considered as screening devices as long as they are within a three foot (3') adjacency and fulfill other requirements of height and density. Antennas, satellite dishes and towers are only permitted if approved by the Airport and shall be screened from view as well.

### E. Hedges

Except as otherwise specifically required in these Standards, no continuous hedge shall be grown, nor shall any fence be constructed or maintained on any parcel boundary or in any setback area or other areas that abut a public roadway.

No hedge shall be grown or fence constructed or maintained on or adjacent to any roadway Setback Line that exceeds five feet (5') in height or elsewhere within Setback lines that exceeds ten feet (10') in height, without the prior written approval of the Airport.



## 4.19 Airport Security

On all parcels adjoining or otherwise having access to the Airport Operating Area (AOA), fences shall be constructed and gates installed and controlled where necessary to restrict the public at large and any unauthorized persons and/or vehicles from access to the AOA. The design and installation of such fences and gates and the methods of guarding said gates shall be subject to approval by the Transportation Security Administration, WRWA and all other agencies having jurisdiction over maintaining the security of the Airport.

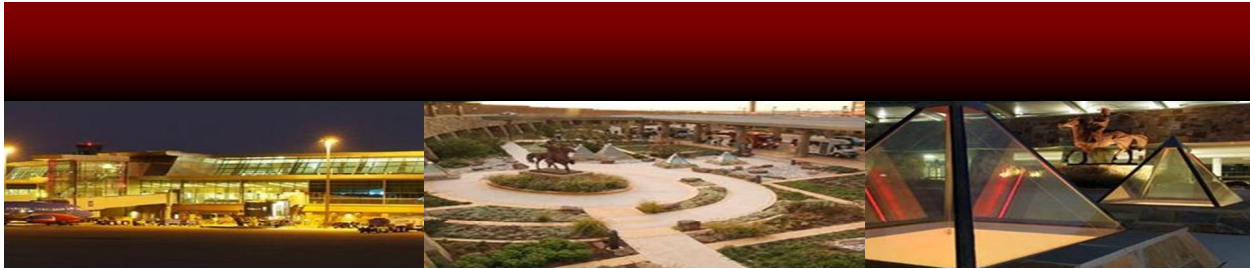

## **5. DEVELOPMENT REVIEW PROCESS**

### **5.1 Overview**

The applicant is required to submit plans for any proposed development to ensure compatibility with the Airport Land Use Plan. Prior to beginning any preliminary design work, tenants are required to submit a conceptual description of any proposed facility, improvements or modifications. This will ensure that the project meets the basic approval of WRWA prior to undertaking any costly engineering and/or architectural work.

Specifically, the development process can be broken into three phases. Phase 1 is the preliminary phase where the project is introduced to the Director of Airports and the lease is negotiated. Phase 2 is the formal plan review by WRWA, the Development Center, the FAA and the Airport Attorney. Phase 3 is approval by the Trust and the construction of the new facility. Phase 1 is working with the Airport to determine the best location for the development, complete preliminary lot survey and development description (drawings), complete the Development Permit Application, initiate ground lease negotiations and pay the development application fee.

Once the Ground Lease Application fee is paid, the Airport will complete the Ground Lease for the tenant to review. This process is usually driven by the tenant and can be completed in as little time as one week.

In Phase 2, the tenant will meet with Airport and Development Center staff to review proposed plans to insure that the development meets the development goal that the Trust has set in place.

Once approval is obtained from Will Rogers World Airport, the tenant must submit signed engineered plans to the Director of Airports. Airport staff will review for compliance to International Building Code as adopted by the Oklahoma City Airport Trust. These codes include the Building, Fire, Mechanical, Plumbing and Energy Conservation codes as well as the National Electrical Code and NFPA 409. See Section 4.2 for a list of the plans that must be submitted.

The Director of Airports will submit FAA Form 7460-1 to the FAA for approval. It is important that the tenant provide the information needed to the Director of Airports so the FAA Form 7460-1 can be submitted in a timely manner.

Once the Ground Lease is executed, the tenant schedules the necessary inspections as required with the Building Inspector. A Certificate of Occupancy is issued when the project is complete and meets all development requirements.

Construction must commence within 6 months of the lease being signed and be complete in accordance with the agreed construction schedule, unless otherwise agreed to by the Trust in writing.

Additional information on the commercial permitting process can be found on the Development Center's website [www.okc.gov/permits](http://www.okc.gov/permits).



## 5.2. Development Approval Phases

### Conceptual Submission

The following information must be included in any conceptual submission:

- History of the company and nature of the business including a list of all major activities proposed, major subleases and capital cost;
- A description of the purpose of the facility, the anticipated types of businesses and an estimate of employment generation;
- A drawing showing the location and size of the development site;
- Location of vehicle and/or aircraft parking and access and loading areas;
- Proposed building dimensions, including height; and,
- Anticipated construction timeframe.

### Concept Design

The following information must be submitted in the concept design phase:

A concept design must be submitted for consideration which shows costs, building design, dimensions, characteristics, relationship to the existing facilities and location of the improvements within the Airport property.

For facilities that are being submitted for consideration as “Designs of Merit”, the concept designs are to be presented to WRWA for approval. Graphic material should include site plans, colored elevations and a perspective of proposed facility in addition to a written description.

The submittal shall include but not limited to plans showing:

- Site area, building location and setback dimensions;
- Pedestrian and vehicular circulation;
- Paved areas and parking configuration;
- Landscaping concept;
- Future expansion areas;
- Proposed utility extensions and connections such as gas, sewer, water and power;
- Fencing or screening with types of materials used;
- Building size, shape and module;



- Preliminary building elevations showing signage, building materials, finishes etc.;
- Description of the waste products that will be produced on site and the method of waste disposal.

The submission is also to include a construction schedule. After review of the Concept Design, the tenant will receive a letter from WRWA specifying the conditions of approval. At this time the tenant will be required to enter into a lease with the Airport Trust prior to undertaking the detailed design development Phase 3. The lease request must be received at least two months prior to the desired date of possession.

### **Design Development**

Once the Concept Design approval has been obtained, a detailed submission must be prepared. Final design documents shall be prepared from the approved schematic plans, and shall include but limited to:

Site plans at a suitable scale showing:

- Existing and proposed grades;
- Parking calculations including base data for projected parking needs;
- Circulation/access to roadway and taxiway;
- Layout and location of all loading areas;
- Location of building and auxiliary structures in relation to existing buildings, aprons and service roads;
- Site coverage data;
- Landscaping plan and plant list with caliper size, species etc.;
- Site lighting (location, height, intensity and fixture type);
- Details of the waste generation and disposal systems;
- Underground utility servicing including water, sewer, power, gas, communications and storm drainage;
- Site drainage;
- Site details for vehicle and aircraft parking areas;
- Security and screen fencing;
- Phasing plan ; and
- Lease boundaries.





Building plans, elevations, and sections at a suitable scale showing:

- A complete layout of all spaces on all floors;
- Dimensions of floor plans and building dimensions;
- Future expansion, if any;
- All construction materials; and
- The arrangement, proportioning and design of windows and doors.

Other information:

- Layout and locations of exterior signs on buildings and property showing their conformance to the airport signage guidelines if applicable;
- Building and roofing material schedule;
- Exterior color schedule/materials (sample board);
- Perspective drawing and/or elevations of building(s) at a suitable scale with accurate representation of colors and materials; and
- Tentative construction schedule.

The tenant will receive written comments from WRWA specifying the conditions of approval. At this time, the tenant is to obtain a building permit through the City of Oklahoma City.

The construction documents shall strictly follow the design approved on the final design submission. The professional responsibility for the content of the construction documents is left to the judgment of the project architects and engineers. One set of complete as-built documents for all facilities shall be submitted to WRWA within two months after completion of construction and will be stored for future reference.

The required number of complete sets of plans per the City of Oklahoma City regulations must be submitted for approval by the Development Center. Each set of plans should include the following:

#### **Architectural Plans**

- Structural drawings.
- Mechanical, Electrical and Plumbing plans (if applicable). These plans should include electrical load calculations.
- Floor plan of the building including uses for each area.
- Exterior elevations.



- ➔ Foundation plans (signed engineered plans).
- ➔ UL assembly numbers for any fire rated walls or partitions.

### Civil Plans

- ➔ Site Plan – must include the building footprint, set backs from property lines, existing and proposed easements, proposed parking spaces with dimensions and location of solid waste container with proposed screening.
- ➔ Utility Site Plan – should include all proposed water, sewer and electric service lines on the site.
- ➔ Site Grading and Drainage Plan – should include storm water runoff calculations for culverts or underground drainage flues.

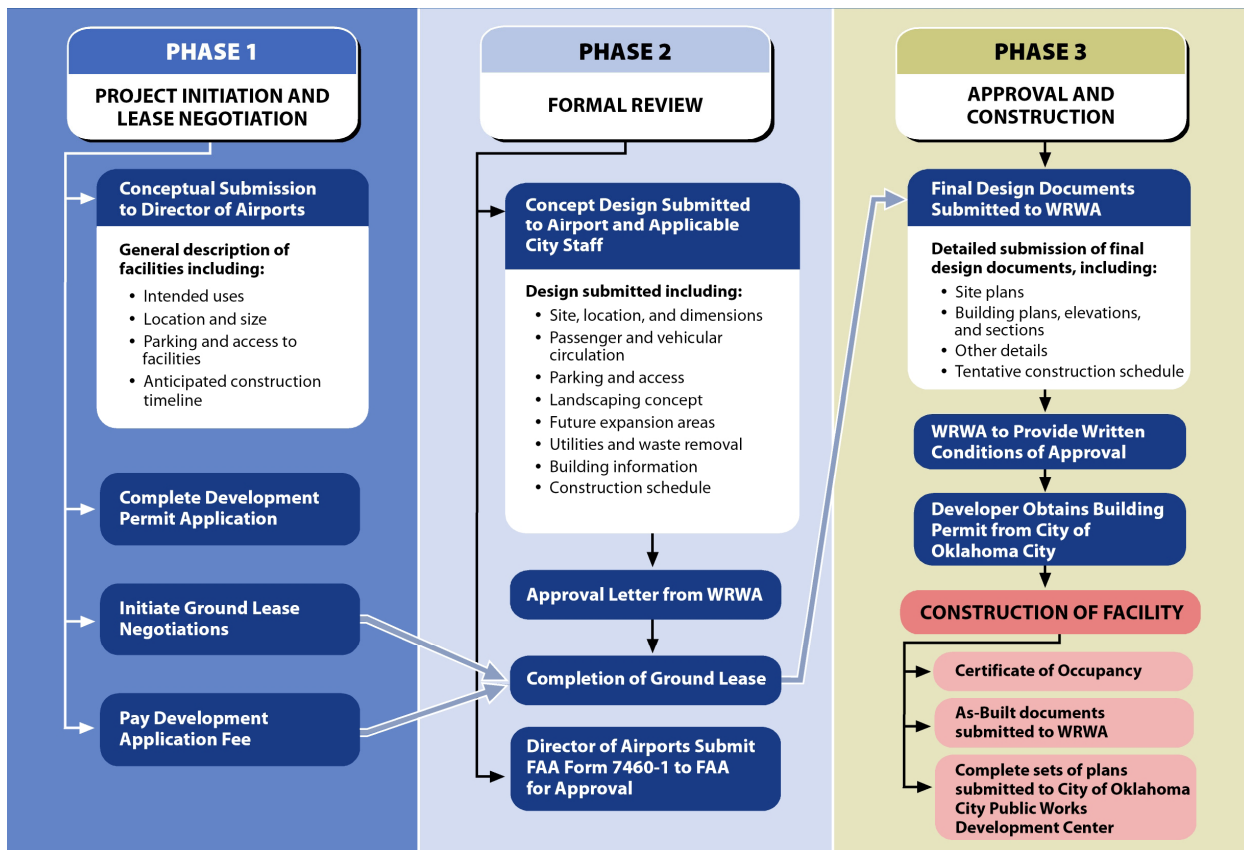

Exhibit 5.1: Development Approval Phases



## 6. AVIATION AND AVIATION SUPPORT DEVELOPMENT

### 6.1 Theme Statement

The purpose of this development area is to present a visually attractive image to the public while recognizing and responding to the highly aeronautical nature of the facilities. As such, these guidelines concentrate on the buildings' images which face the public streets with less emphasis on the facades facing airside.

### 6.2 Building Massing

Buildings under this development area fall into two building massing categories, namely single occupancy buildings and multi-occupancy buildings.

### 6.3 Single Occupancy Buildings

All the buildings will be considered to be comprised of two fundamental components, namely the shop/hangar portion and the office/public entrance portion. The office component and its public entrance should face towards the front yard and the public street as illustrated in Exhibit 6.1. In the case of a corner lot, only the yards facing the major streets are considered front yards.

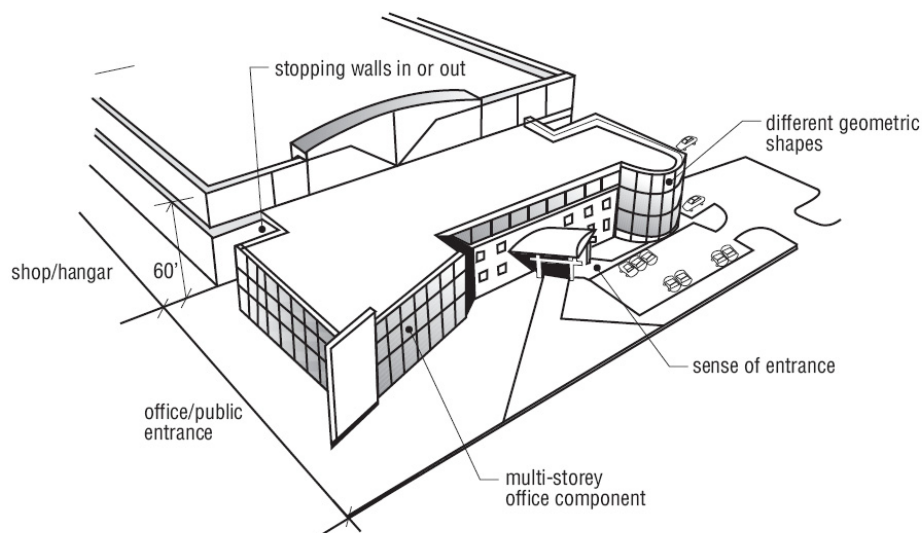

**Exhibit 6.1: Single Occupancy Building Layout**



Every public entrance is to be clearly expressed architecturally to create a strong building/corporate image and sense of entrance. Massing changes, color, material changes and entrance canopies are all examples of architectural devices which can be employed to create an appropriate sense on entrance. Maximum building height is the height limit required for aeronautic operations or other limits imposed by the Airport.

The massing of the shop/hangar portion of any facility and the massing of the office/public entrance portions are to be distinct and different in profile. For example, a facility which has a large hangar structure and a protruding lower scale single storey attached office component is acceptable over a plain structural box with minimal windows and entrance doors. Architectural devices such as different roof planes and height, using geometric shapes for the different portions of the facility, stepping walls in or out between the shops and office components are all examples of devices which create visual interest. The office component should be one storey in height. A two storey office component is permitted providing there is a distinct change in massing from the hangar portion of the facility.

## **6.4 Multi – Occupancy Buildings**

All buildings in this category are considered to have a shop/hangar component and an entrance component for each individual occupant. Any office function may be considered to be part of either the shop/hangar or the entrance components.

The entrances are to be paired together. Each one of these paired entrances is to protrude out of the face of the shop/hangar wall by a minimum of 5 feet (5'). In the case where there is one common office/public entrance for all occupancies in the building, the massing guidelines for a single occupancy building apply.

## **6.5 Building Materials**

The hangar/shop exterior wall elevations can be finished in either split faced masonry, stone, brick, prefabricated architectural metal panels, glass construction or pre-finished corrugated metal siding. The office exterior walls are to be clad in a different yet complementary material to these used on the shop walls. Any glass with direct sunlight exposure must have a maximum 31% emissivity.

## **6.6 Roofs**

Metal roof colors shall be either white or light color and with a non-reflective finish. Sample colors are to be submitted and are subject to approval by the Airport. All rooftop equipment, piping, flashing and other items which are exposed shall be finished to match roof surface color. Roof top equipment is to be screened from view at ground level from the front and side yards.

## **6.7 Roof Drainage**

All of the storm water control is being engineered using an over land drainage system. Therefore, all roofing drainage is to be collected and channeled to grade via a pipe system integrated into the fabric of the building. Water is not permitted to be simply shed off or channeled through scuppers directly off the roof.



## 6.8 Landscaping

All landscaping is to be developed in accordance with Section 4.11 of these standards.



## **7. NONAERONAUTICAL DEVELOPMENT**

### **7.1 Theme Statement**

The purpose of this development area is to showcase a critical mass of some of Oklahoma City's finest corporations in industrial, research, high technology and other related business fields, thereby creating an immediate impact on visitors. Visitors will be impressed with the sophistication and the range of diversification that the Oklahoma City region's businesses have to offer.

### **7.2 Elevation & Massing Concepts**

The massing and elevation concepts for any facility in this area are to make a unique architectural statement about the corporation or its internal functions. All of these facilities are considered "Design of Merit". Therefore, each design will be reviewed and/or approved or rejected on its own merits. Each facility design team must demonstrate the merits of their. Whether or not a design has sufficient merit is at the sole discretion of the Airport.

Multi-story structure for the office portions of the facilities is encouraged. No pre-engineered buildings are permitted in this area.

### **7.3 Building Massing**

All buildings will be considered to be comprised of two fundamental components, namely the shop portion and the office/public entrance portion. The massing of the shop portion of any facility and the massing of the office/public entrance portions are to be distinct and different in profile. Architectural devices such as different roof planes and height, using different geometric shapes for the different portions of the facility are suggested to create visual interest.

The office component and its public entrance should face towards front yard and the public street. In the case of a corner lot, the major streets are considered to have the front yards. Every public entrance is to be clearly expressed architecturally to create a strong building/corporate image and sense of entrance. Massing changes, color, material changes and entrance canopies are all examples of architectural devices which can be employed to create an appropriate sense of entrance. The maximum building height is the height limit required for aeronautical operations or other limits as determined by the Airport. The maximum building height is not to exceed 60 feet (60'). An illustration of the building layout is provided in Exhibit 7.1.

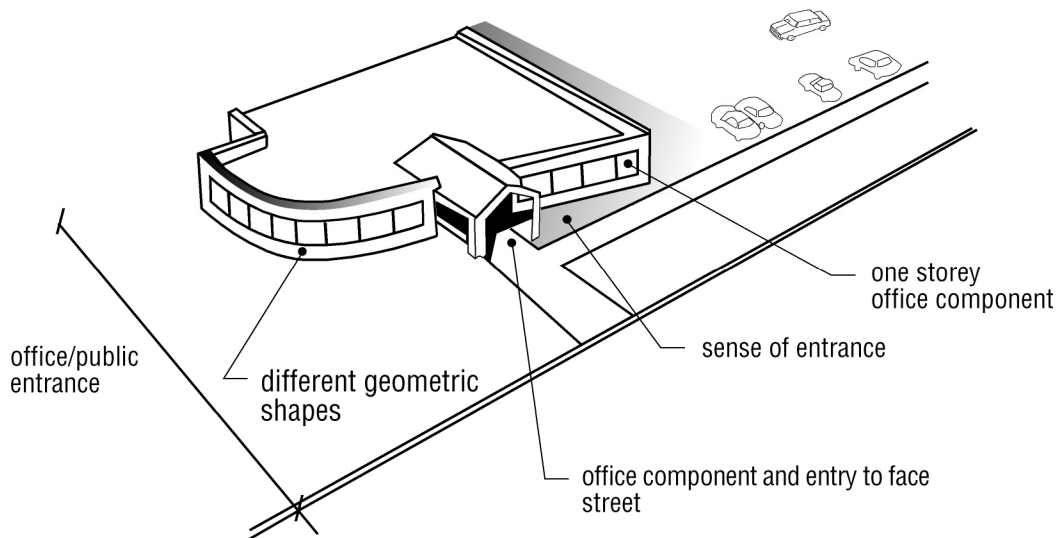
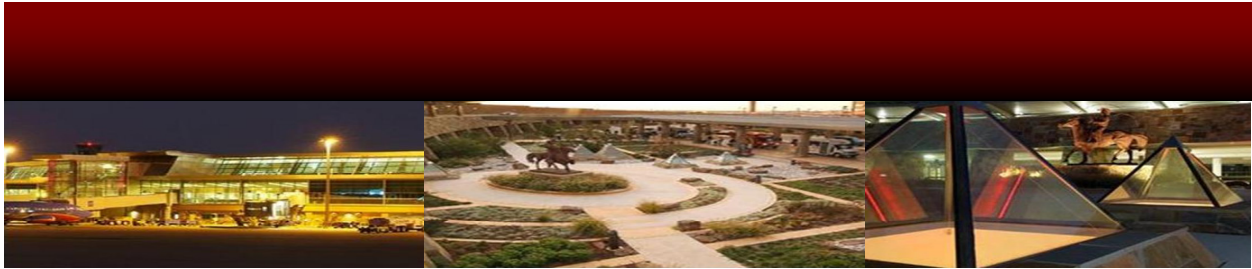

**Exhibit 7.1: Nonaeronautical Building Layout**

## 7.4 Building Materials

All the shop and office elevations are to be clad in either split faced masonry, stone, brick, pre-fabricated architectural metal panels and glass construction. Pre-finished corrugated metal siding is only permitted if it can be demonstrated that it helps to support a concept of a “high tech” building image.

Any wall planes higher than 20 feet (20') shall be visually broken up into wall areas which are no greater than 15 feet (15') high. Architectural devices for achieving this requirement are: changes in materials, changes in material profiles and massing, changes in material colors, accent banding, strip windows, canopies and/or a graphic package. The use of other creative architectural devices to create visual interest is also encouraged.

## 7.5 Roofs

The storm water control is to be engineered using an underground collection system for this area. Therefore, all roof drainage is to be collected via an internal pipe system within the building.

## 7.6 Additional Landscaping/Berming

To supplement the landscaping required as outlined in Section 4.11; additional landscaping is to be provided at the entrance to each building developed in this area. This additional landscaping is to include, but is not limited to the following:

- Feature shrub planting at the base of the building and at the building entry walkways; and



- Tree planting at the building entrance to help define and highlight the high quality entrance way.

Of the required landscape modules developed along public roadways, 50% of the deciduous trees are to be 4" caliper in size at minimum. On all lots adjacent to the greenbelt, the yards abutting the greenbelt are to be developed using Landscape Module "B" at a rate of 1 module per 165 feet (165') and using a 3 foot (3') height berm centered on the property line.

## 7.7 Drainage

If drainage swales are required, their design should be coordinated with WRWA and OKC Public Works Department.



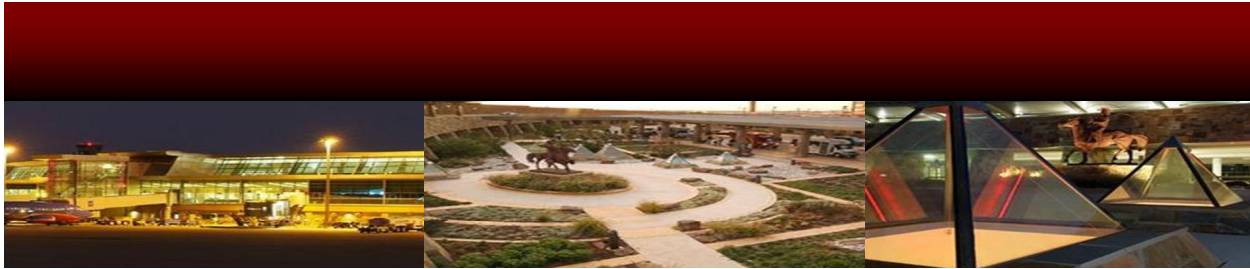

## **8. CONSTRUCTION REQUIREMENTS**

### **8.1 Ground Lease**

The Director of Airports shall issue Notice to Proceed after all documents and plans have been approved.

### **8.2 Contractors**

The tenant is responsible for hiring, acquiring Contractors, sub-contractors and suppliers that are qualified.

### **8.3 Permits**

All permits, approvals and development agreements required by the City including but not limited to FAA Part 77 approval, Building Permits, approvals to tap domestic water lines and to access OG+E's electrical distribution panels, shall be acquired prior to commencing construction activities or delivery of materials to the site. The Design consultant shall be responsible for submitting the Construction Contract Drawings and Specifications to the City's Development Center for plan reviews and for receiving approvals sufficient to allow the Contractor to obtain the necessary permits.

Charges for permits, approvals, tap fees and development agreements required by the City shall be at the tenant's expense.

The Contractor, before commencing work, shall verify all governing dimensions and field conditions at the work site, and shall examine, to the extent reasonable, all adjoining work and systems and substrates on which its work is in any way dependent according to the Approved Construction Contract Documents, and no disclaimer of responsibility for defective or nonconforming adjoining work will be considered unless written notice of same attached with the Acceptance of Premises Form has been filed by the Contractor, and agreed to in writing by the Airport before the Contractor begins any part of the affected work.

### **8.4 Contractors Environmental Protection Plan**

Prior to commencing construction activities or delivery of materials to the site, the Contractor shall submit an Environmental Protection Plan for review and approval by the City of Oklahoma City. The purpose of the Environmental Protection Plan is to present a comprehensive overview of known or potential environmental issues which the Contractor might address during construction.

Prior to submittal of the Environmental Protection Plan, the Contractor shall meet with the Airport for the purpose of discussing the implementation of the initial Environmental Protection Plan, possible subsequent additions and revisions to the plan including any reporting requirements, and methods for administration of the Contractor's Environmental Plans. The Environmental Protection Plan shall be current and maintained onsite by the Contractor. The contractor is required to acquire and maintain any necessary permits for construction from the City of Oklahoma City Stormwater Quality Management Division and the Oklahoma Department of Environmental Quality,



The contractor shall provide designation of a single individual representing the tenant for all spill-related matters, and 24-hour contact information for that individual.

## **8.5 Security Requirements**

The Airport and FAA Security Regulations stipulate special procedures and construction requirements for development that are in or adjacent to the airside. These include the Security Escorts, and Fencing and Security requirements. Specifically, the tenant, contractors, and all persons must comply with the Transportation Security Administrations Part 1542 and 1544 regulations while working on the Airport property. Security fencing and all access points must meet the standards of the Airport's Security Plan at all times.

## **8.6 Temporary Water Supply**

If water is required for preloading or other construction activities, the tenant shall contact the City of Oklahoma City for meter and billing requirements.

## **8.7 Water Connections**

The City of Oklahoma City will supply all water service connections to all developments at a cost. The size of the connections is to be determined by the tenant's engineer. The water service will not be made until the tenant has furnished the Airport with all tests reports related to the water service (Backflow prevention reports, Chlorinating reports and signed reports of system been flushed and all other relevant test reports). All temporary water connections to fire hydrants are to be made by the contractor using the City of Oklahoma City furnished and charged for flushed meters. They will install the appropriate backflow device on the hydrant. There will be a charge for this service and the water will be metered and the cost of the water will be billed to the tenant. Notice of the required connection will have to be given to the Airport 72 hours in advance.

## **8.8 Electrical and Telecommunications Services**

All electrical and telecommunications distribution is to be provided underground. The objective is to reduce aeronautical obstructions. Installation of power poles is not acceptable.

## **8.9 Road Crossings – Site Services**

Where site servicing crosses airport roads, directional drilling shall be used for installation rather than trenching unless approved in writing by the Airport.

## **8.10 Responsibility for Site Service Connections**

The tenant is responsible for providing all site service connections to the site including those beyond the lease line unless special arrangements with the Airport have been made. All connections are to be witnessed and approved by the Airport.



## **8.11 Underground Services Specifications**

Specifications shall meet or exceed City of Oklahoma City Engineering Standards.

## **8.12 Clean up and Reclamation**

The tenant/contractor shall be responsible to maintain a clean construction site and to repair any damage to other sites caused by construction to as a good or better condition. A covered dumpster or other appropriate covered receptacle shall be placed on the site prior to construction and shall be used for all waste materials. If the tenant fails to maintain these areas, the Airport reserves the right to maintain them at an additional cost to the tenant. All areas disturbed during hangar construction, including utility trenches, must be cleaned up, backfilled and compacted.

## **8.13 Temporary Buildings**

Temporary buildings must be approved by the Airport as to type, use, design and location on an individual basis for a specified term. The removal of temporary buildings will be completed by the tenant before final occupancy is awarded. Temporary buildings such as tents or membranes are not permitted.

## **8.14 Safety Program**

Contractors are responsible for the health and safety of its employees, agents, subcontractors, subordinate contractors, suppliers, and other persons on the construction site. The Contractor shall take all necessary and reasonable precautions and actions to protect all such persons from injury, damage, or loss. Such actions shall include, but are not limited to, compliance with all applicable federal, state, and local regulatory measures.

### **A. Contractor Submittal**

Before the Contractor will be permitted by the Airport to commence any construction or construction related activities on the Airport or the surrounding roadways or property, the Contractor must develop a written safety program addressing the specific methods that will be used to implement the safety procedures and submit the names and both home and office telephone numbers of the personnel who will directly supervise the safety program and the work. Names and telephone numbers shall be submitted at the preconstruction conference to the Airport. The Contractor will receive applicable information at a preconstruction conference to develop the safety program.

### **B. Review Process**

The Airport will review the safety program, and the FAA Airports District Office and the FAA Control Tower Manager (as appropriate) for compliance with applicable regulations prior to approving the program. If the plan fails to demonstrate compliance, the plan will be returned to the Contractor for modification until compliance is reached.



### **C. Requirement for Trained Supervisors**

The Contractor must employ at least one safety trained supervisor for each separate work crew that is working within the Airport. The Contractor shall submit to the Airport the names of the safety trained supervisors and shall provide updated lists as changes occur.

### **D. Identification Badges.**

Supervisors will be required to obtain badges from Airport before they are permitted to work within the AOA. Application forms will be provided by the Airport.

### **E. Radio Communications**

Contractor supervisory personnel must have radio communications established as required by the Department of Airports.

### **F. Contractor Vehicles**

The Contractor shall use the minimum number of vehicles that, in the opinion of the Airport, are necessary to efficiently execute the work. The Contractor shall submit with the safety plan a list of the number and identification of vehicles that are planned for use. The Contractor must store vehicles that are not in use either in approved staging areas or off airport property. Personal vehicles will not be permitted unless specifically authorized. Contractor vehicles must be clearly and distinctly marked with the contractor's corporate name and logo. Magnetically attached signs are permissible. The distinctive markings must be large enough to be read without magnification from a distance of not less than 500 feet.

Any vehicle that will be used to transport personnel or escort other vehicles or equipment on or across active taxiways, runways or aprons must be permitted and equipped with the identification and be equipped with a bright yellow or amber 360-degree strobe rapidly blinking light visible to the control tower personnel from anywhere on airport (when not obstructed by buildings) and be equipped with a radio capable of communicating with the Ground Traffic.

## **8.15 Inspections**

Once the project has been approved by the Airport and construction starts, there are certain inspections that will be required during each stage of the construction process. It is the responsibility of the contractor to insure that the proper inspections are requested and approved prior to proceeding with construction. The Development Center will determine which inspections are needed after reviewing the project with the contractor.

## **8.16 Record Documents Generated by Construction**

Upon completion of the project, as-built drawings of all development and all underground utilities within any required utility easement area must be furnished to the Airport within 30 days after the Certificate of Occupancy is issued.



## 8.17 Construction Standards

The Contractor shall use quality standards for construction including the grades of materials, thickness, strengths, any national standards that must be met, any samples that must be submitted, any testing required to assure quality, any experience of required installers, all fabrication and installation tolerances and other related quality items.

## 8.18 Project Control

Contractor shall employ a competent superintendent whose qualifications shall be acceptable to the Department of Airports. The superintendent shall serve on a full-time basis at the work site and shall be authorized to act on behalf of the contractor. The Department of Airports has the power to immediately stop or modify the work program and shall attend job coordination meetings as required. The Superintendent or his/her designated representative must be on-site at all times when on-site work is performed.

## 8.19 Building Materials and Engineering

Materials shall be appropriate for the use and type of structure for which they are used. Buildings shall be designed to minimize or prevent predictable damage and deterioration. Materials that may be used include exposed decorative concrete, glass, brick, pre-finished, preformed metal, and natural stone. The type, style, and color of all exterior materials shall be submitted to Airport for approval. Material samples are required.

- A. Foundations: All buildings shall be founded on concrete footings with concrete floors. These footings shall be so designed and constructed to adequately support the proposed building(s).
- B. Fire Protection: All buildings shall meet or exceed the Fire Code and Building Code of the City of Oklahoma City for fire protection. A fire alarm system shall be installed in any new structure or undergoing a major renovation. The fire alarm system installation shall conform to NFPA 72 requirements.
- C. Exterior Colors: All exterior surface colors shall be compatible with colors specified in Section 10.1 or as approved by the Airport.

## 8.20 Type of Construction

- A. Building Materials: A minimum of fifteen percent (15%) of the exterior building façade materials on each elevation, except on elevations facing the ramp, shall be native Stone to compliment the terminal building materials. The remainder of the façade to be a combination of concrete, masonry, hardi-plank materials, or wood that has been treated to resist fire, rot and insects, with a maximum amount of allowed wood being no more than ten percent (10%) and only being utilized for accent and decoration purposes. Concrete, masonry, and treated wood siding shall be kept neatly painted, if used. State of the art changes in types of construction may be permitted from time to time only upon

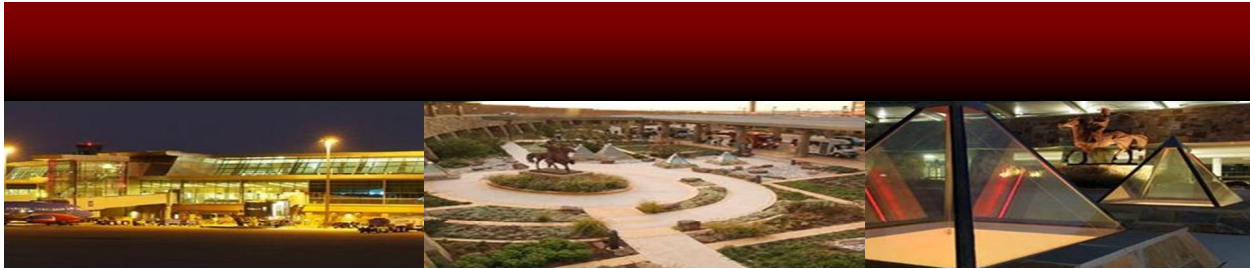

the express condition that any change be consistent with the intent of these standards. Pre-fabricated metal buildings are specifically prohibited.

- B. Roof Screening: All heating and cooling towers, equipment, etc., placed on the roofs of Buildings shall be screened or enclosed from view so that they are architecturally compatible with the main portion of the Building.
- C. Accessory Buildings, Enclosures and Fences: Accessory buildings, enclosures, and fences shall enhance the design of and be of the same quality materials as the buildings they serve. Chain-link fencing is specifically prohibited.
- D. Building Codes and Ordinances: All buildings shall conform to all local building codes and ordinances.
- E. Approval by Director of Airports: The type of building construction proposed shall be subject to the written prior approval of the Director of Airports as authorized agent of the Airport. The tenant is encouraged to use natural material and native rock in the exterior elevations of Improvements.

## 8.21 Pipes

No water pipe, gas pipe, sewer pipe, or drainage pipe (other than those within structures) shall be installed or maintained on any development site above the surface of the ground except hoses and movable pipes used for irrigation or similar purposes. Backflow preventers, as required by the City of Oklahoma City, shall be screened from view. Any roof-top pipes required for the function of the structure shall be properly secured.

## 8.22 Hazardous Activities

Contractor shall exercise the utmost care and caution if the storage and use of hazardous materials or explosives are required for the performance of work. Activities related to the purchase, storage, use, removal, treatment and disposal of such hazardous materials shall be supervised and carried out by personnel properly qualified to perform such activities. In no circumstances shall activities requiring the purchase, storage, use, removal, treatment or disposal of hazardous materials be started without first notifying the Airport in writing of the proposed activity and receiving written approval of such action. The use and storage of explosives will not be allowed on site.

## 8.23 Utility Line Connections

The Airport will provide a utility corridor throughout the Development Area. Connections points will be placed along the corridor for tenant access. However, connections to each utility along the corridor must be coordinated with the Airport and the appropriate utility agency. All underground utilities installed by the tenant shall be marked with magnetic tape to provide surface detection capability.



## 8.24 Excavation

No excavation shall be made by a tenant unless the excavation is directly related to the construction of an improvement. When construction is complete, all disturbed ground shall be filled or graded and shall be landscaped in accordance with the Airport Development Standards.

## 8.25 Protection of Property and Work in Progress

Contractors shall take all reasonable precautions for the safety of, and shall provide all reasonable protection to prevent damage, injury, or loss to:

- All work and all materials, equipment, systems, fixtures, and furnishings to be incorporated therein, whether in storage on or off the construction site, under the care, custody, or control of the contractor, subcontractors, subordinate subcontractors of any tier, or suppliers; and
- Other property at the construction site or adjacent thereto, including without limitation, lawns, walks, pavements, roadways, structures, and utilities not designated for removal, relocation, or replacement in the course of construction.

## 8.26 Grading and Site Drainage

Grading shall be designed to be consistent with the approved drainage/grading plan for the Airport lands and consistent with the Airport drainage system.

All individual on-site uses areas shall be provided with necessary drainage structures to drain those areas. All site drainage shall be disposed of by an on-site storm drain system subject to approval of WRWA and of the Public Works Department of the City of Oklahoma City. Site drainage may be diverted into existing Airport drainage facilities provided there is adequate capacity. The design of grading shall be intended for proper erosion control, low maintenance, high durability, and positive flow.

Site drainage shall be based on, but not limited to City of Oklahoma City Standards for streets, sewers and related projects; all developments shall retain stormwater on site to the extent that post-development runoff shall not exceed pre-development runoff.

For Airside and General Industrial areas where drainage swales are required, they are to be developed within a drainage easement within the property lines. These swales are to be developed with grass at minimums.

Fuels, lubricants and other toxic or insoluble compounds may not be permitted to discharge into the surface or underground stormwater system without such prior processing as to render them innocuous. Discharge of aircraft toilet wastes anywhere other than into designated sanitary sewer collection points is expressly prohibited.



## **8.27 Sustainability/LEED**

The Airport is committed to environmental sustainability and as such gives preference to tenants who demonstrate their commitment to the design and implementation of sustainable building technology, including minimization of building waste, recycling, energy and water efficiencies and improved environmental outcomes. The consideration of LEED certified green buildings are encouraged and will serve as examples for future projects at the Airport.

## **8.28 Site Access**

Access to the development site during construction shall be limited and will be determined and coordinated with the Airport and the City of Oklahoma City Police and Fire Departments. All persons and vehicles entering the construction site must be properly authorized to do so and must enter at the designated site entrance gate locations. The Contractor shall be responsible for assuring the Airport that all persons and vehicles required are in possession of valid access authorizations and for returning same to the Airport upon final completion or termination.

## **8.29 Construction Maintenance**

The worksite and other areas used by the Contractor shall at all times be kept free of accumulated waste materials, dirt and surplus material. The tenant is responsible for ensuring that their Contractors appropriately store, label, manage, transport, and dispose of construction wastes at an appropriately permitted offsite facility.

Following notice of completion, the Contractor shall, as soon as practicable, remove all waste materials, excess materials, tools and equipment. In addition, all construction projects must be clean and ready for full use before it is given a final inspection. The tenant shall ensure that all clean-up is done to the satisfaction of the Airport. Measures are mandatory on Airport property. The tenant is responsible for the security of the leased area and will be required to provide a security system for its agents, contractors, and employees within the construction area.

The Contractor shall contain its storage and laydown materials, equipment and tools and its operations within the premises and such other area as may be assigned by the Airport.





## **9. BUILDING DESIGN**

### **9.1 Introduction and Approach**

This architectural criterion is designed to promote the creation of a unified campus-like character to the WRWA Commercial Land Development area. It is intended that this framework provide flexibility to allow for the development of a wide range of building types, sizes, and uses, while maintaining a consistently high level of quality, sustainability and design. Acknowledging that each use has its own unique requirements and budget, the consistent application of these standards is meant to assure the integrity of future development.

The buildings placed within the WRWA Commercial Land Development area should reflect both the advanced technological image associated with aviation and the Oklahoma environment in which they are sited.

The character of the architecture is to be progressive, functional and enduring. Innovation in design, structure, and materials is encouraged. Given the millions of passengers using Will Rogers World Airport, care should be taken to make the sites and buildings coherent when viewed from the air.

### **9.2 Basic Design Principles**

- A. **Building Form:** Building massing, forms and articulation shall have horizontal emphasis. Simple volumes that blend with the landscape are preferred. Big Box structure shall incorporate material changes, projections and significant off-sets to break-up the massing.
- B. **Detailing and Articulation:** The level of architectural detailing shall be reasonably consistent on all sides of a building. Facade materials shall be clearly articulated and consistently applied.
- C. **Entries:** Entries should be easily identifiable destination points as viewed from parking areas and the road. Primary entry points should be recessed or sheltered. Entries should be scaled in proportion to the facade in which they are placed.
- D. **Shading Devices:** The use of passive solar shading devices is encouraged. Such devices should be appropriate to the orientation of openings to which they are applied; i.e. north facing facades should differ from those oriented to the south.

### **9.3 Prohibited Features**

Unless allowed by site specific development criteria issued or approved by WRWA.

- A. Non-functional ornamentation, structure, or decoration inconsistent with the architecture character.
- B. Historical or regional styles and elements such as arches, domes, moldings, cornices, pediments, and ordered columns (ionic et al).



- C. Simulated structure, windows or materials.
- D. Fabric awnings and canopies.
- E. Arbitrary, whimsical, or fad-oriented architecture.
- F. Over-scaled or ostentatious entries or features.
- G. Wood siding, shingles, or trim, composition shingles, clay or concrete tile roofing.

## 9.4 Roof Forms, Drainage and Screening

- A. *Roof Forms*: The variety of roof forms is limited in order to maintain a sense of unity within the development areas. These forms are low-slope, shed, or curved. Hip, mansard, gable, and barrel vaults are not permitted. Unique “corporate” type of roof styles may be presented for Airport review and consideration but any approval shall be granted only on a case by case basis.
- B. *Low-Slope Roofs*: Low-slope roofing is defined as roofing that is typically installed at slopes of less than 2:12. This includes built-up, single-ply, modified bitumen and other similar systems. Low-slope roofing must be concealed behind parapets.

While low-slope roofing may be any neutral color, lighter shades are encouraged to minimize heat gain. Since the roofscape will be frequently viewed from the air, care should be taken in the placement of roof elements such as traffic pads and equipment. Low-slope roof drainage should be by means of internal drains. Overflow scuppers may be visible provided they re located and detailed to harmonize with the building façade.

- C. *Pitched Roofs*: Pitched roofs are defined as exposed, straight-run roofs with a slope greater than 2:12. Slopes shall not exceed 4:12. Mansard roofs are not acceptable.

Exposed pitched roofs must be clad in architectural grade metal with no exposed fasteners. Acceptable materials are listed in the Architectural Color Palette (Section 10.1) and Materials (Section 10.2) of this document. Exposed architectural roofing may have visible gutters and downspouts that are clearly detailed and articulated as part of the over all building design.

- D. *Curved Roofs*: Curved roof forms should be graceful, low arcs. Barrel vaults (180-degree radius or semi-circular) are not permitted. Other than slope, all standards listed for shed roofs apply to curved roofs as well.
- E. *Roof Screening*: All roof mounted mechanical systems and communications equipment should be screened from the public roadways in a manner architecturally consistent with the building as a whole.

Screening shall be walls or louvers in a material and finish matching or complimenting the roof (if shed or curved) or the facade material or color.



Stacks, vents, or tanks that cannot be screened should be finished in approved materials and colors and be designed integrally with the architecture of the entire structure. Such items should be placed in an organized manner when visible.

- F. *Drainage*: Storm water shall not leave the site faster or at an increased volume from current conditions without the approval of the City of Oklahoma City.

## 9.5 Building Lighting

Buildings should be lighted in a manner that emphasizes internal glow and transparency.

- A. Entire facades should not be floodlit. Building-mounted lighting may be used to accent architectural features or modules.
- B. Building lighting shall be oriented so that light is not directed towards sky, streets, adjacent properties or the FAA Air Traffic Control Tower.
- C. Entries should be illuminated so as to highlight their location. Likewise, pedestrian paths should be lit using bollards or similar low level fixtures.
- D. Light sources should be shielded from streets and adjacent properties.
- E. Exterior architectural accent lighting shall be “white” light including fluorescent, metal halide, halogen.



## 10. ARCHITECTURAL MATERIALS

### 10.1 Color Palette

- A. Building exteriors should consist of neutral earth-tone palette of materials. Individual material colors are listed in this section where available, otherwise paint colors referenced below are to serve as a guide in selecting appropriate colors.
- B. Unique branding colors may be used in limited areas, i.e. at any entry or on a particular architectural feature. These colors should not be distributed over entire facades as stripes or trim and should be scaled so that they are proportionate to the façade in which they are located. They are not to act as advertisements or billboards.
- C. General paint colors are: warm gray, cool gray, tan, buff, white, black and brown.
- D. Acceptable Kynar metallic colors: silver, silver gray, pewter, champagne, gold, copper metallic, light bronze, medium bronze, dark bronze, medium gray.

### 10.2 Materials

- A. The following listing of materials is intended to encompass the range of acceptable major architectural materials, colors, and finishes for WRWA Commercial Land Development area.
- B. While individual manufacturers or proprietary terms may be listed as examples there is no intention to limit acceptable materials to a single supplier.
- C. New or emerging technologies that may produce materials not listed at the time of printing of this criteria will be considered.
- D. Natural Finish materials:
  - 1. It is recommended that a minimum of 50% of the front yard elevation consist of natural finish materials. To compliment the terminal building, 15% of the façade should consist of native stone.
  - 2. A minimum of 25% of the other elevations shall consist of natural finish materials.
  - 3. Natural finish materials include:
    - Sand-blasted concrete
    - Textured concrete
    - Exposed aggregate concrete
    - Native Stone



- Glass
- Anodized aluminum
- Stainless Steel
- Unpainted Brick
- Unpainted CMU (split-face, scored, ground-face)
- Factory finished metal panels

### 10.3 Brick

- A. Brick shall be modular, clay fired units meeting or exceeding industry standards for quality including but not limited to: ASTM-C216-87 and ASTM C90.
- B. Texture/style: uniform face texture such as wire-cut smooth. “Antique” style brick are not permitted.
- C. Bond: any uniform pattern such a running or stack.
- D. Color range: light, warm tones such as sand, cream and buff. Examples include: Acme #105, #107, and #114. Brick should be relatively uniformed in color rather than varied “blends”.
- E. Mortar color should complement the brick color.

### 10.4 Concrete Masonry Units

- A. CMU shall be modular units meeting or exceeding industry standards for quality including but not limited to ASTM-C219 and/or ASTM C90.
- B. Texture/style: uniform face texture such as smooth, burnished, split, scored, ribbed, or ground-face.
- C. Bond: any uniform pattern such as running or stack.
- D. Color range: light, warm tones such as warm gray and buff. Examples include Featherlite “Limestone” and “Saddle Tan”.

### 10.5 Stone Veneer

- A. Size: cut stone veneer shall be sized as appropriate for the type of stone and the method of installation. Stone exceeding two inch thickness may be set using mortar and anchored to structure when the system is designed to conform to recognized industry standard for installation and height. Thinner stone or taller applications must be supported by a building structure engineered in accordance with the highest standards. Stone may not be set on facades using adhesive methods.



- B. Acceptable types include: Limestone: Indiana: Buff, Texas, Cordova Cream, Lueders, Shellstone, Cedar Hill Cream, or Hadrian. Other warm toned natural stones such as native stone, sand and granite.
- C. Finishes: may consist of polished, flamed, honed, filled or unfilled.
- D. Stone pieces must be cut modules and installed in a regular grid pattern.

## 10.6 Metal Panel Systems

- A. All metal panels shall be fully engineered architectural quality systems. Fasteners shall be either fully concealed or integrated into the panel design on any panels exposed to view. Panel systems shall be designed for uniformity and flatness. Corrugated or “metal” siding is not acceptable.
- B. Material standards:
  - 1. Steel: G-90 (1.25 oz) hot-dipped galvanized, ASTM A924 and ASTM A653.
  - 2. Stainless steel: Type 304 AISI architectural grade alloy.
  - 3. Aluminum: Alloy 3003.
- C. Finishes shall be a factory applied and warrantee system, paint coating should consist of a minimum of 70% Kynar or Hylar resin no less than .8 mil thicknesses over a compatible primer. Anodized finishes may range from clear to dark bronze.
- D. “Galvalume” steel shall be hot dip coated with aluminum-zinc alloy.
- E. Profiles/textures: smooth, embossed, or ribbed. Examples include Centria “Formawall”, “Versapanel”, or “Super Rib”.
- F. Colors: Galvalume, stainless steel or colors as listed in Section 10.1.
- G. Minimum panel articulation dimension shall be eighteen-inches.

## 10.7 Architectural Metal Roofing

Acceptable architectural roofing materials are aluminum, steel or copper. Roofing must be installed over continuous substrate. Acceptable finishes:

- Steel or aluminum: galvalume, zincalume, or a factory applied baked on paint system such as silicone modified polyester (SMP) or polyvinylidene fluoride (PVF2) in approved color as listed in Section 10.1.
- Copper or aluminum: Natural.



## 10.8 Stucco

Cement based three-coat system on metal lath over appropriate substrate. Control joints and reveals shall be extruded aluminum. The top color coat may be colored cement or an acrylic product such as STO finish. EIFS is only permitted nine feet above the first floor elevation.

## 10.9 Concrete (Vertical Surfaces)

Exterior concrete wall surfaces shall be textured (i.e. form liner), sandblast, water blast or exposed aggregate, painted or stained.

## 10.10 Glass and Frames

- A. Vision glass should be warm toned, gray or black; colored tints or coatings (i.e. blue, green) are not permitted.
- B. Spandrel glass color is subject to Section 10.1 if not matching vision glass color.
- C. Highly reflective glass is not permitted.
- D. Examples of acceptable types include PPG Solarbronze and Viracon Bronze
- E. Aluminum framing is subject to colors listed in Section 10.1

## 10.11 Paving

- A. Paving must be reinforced concrete, asphalt, modular concrete pavers, or cut natural stone.
- B. Drives and streets must be concrete, unless otherwise approved by the Airport and should be designed to support the expected loads typical for the use of the site.
- C. Stamped colored concrete patterns simulating pavers or stonework is permitted.
- D. An eight-foot wide bank of stamped, colored concrete complying with WRWA Standards shall be provided across all tenant driveways. Bank aligns with lease line and projects into street right of way.

## 10.12 Hardscape

Sidewalks and pedestrian paving at the main visitors' entry(s) shall be sandblasted concrete, exposed aggregate, pavers, stamped concrete, stone, or other such materials, with a gridded joint pattern no larger than 30 inches.

## 10.13 Wood

Wood is to be no more than ten percent (10%) and only being utilized for accent and decoration purposes unless otherwise approved by the Airport.



## 10.14 Fencing

- A. Fencing in areas not facing the front yard(s) may be galvanized chain-link type fencing. Chain-link fence must be screened with landscaping on the outside.
- B. All other fencing should be painted architectural metal, masonry, pre-cast or poured in place concrete, and shall comply with the other criteria of the section.
- C. No wood or plastic fencing shall be approved.
- D. Any fence with perforations or of chain-link type construction must be mounted on a continuous mow strip of concrete extending twelve inches each side of fence.

## 10.15 Retaining Walls

Retaining walls maybe constructed of cast-in-place concrete, brick , precast concrete units, sandblasted and rusticated joint concrete, concrete masonry unit systems or stone. Timber retaining walls are not permitted. Retaining walls of more than two to six feet (2'-6') in height are to be terraced so that each lift is not greater than two to six feet (2'-6').





## Appendix A

### FAA FORM 7460 AND INSTRUCTIONS



## NOTICE OF PROPOSED CONSTRUCTION OR ALTERATION

### §77.13 Construction or alteration requiring notice.

(a) Except as provided in §77.15, each sponsor who proposes any of the following construction or alteration shall notify the Administrator in the form and manner prescribed in §77.17.

(1) Any construction or alteration of more than 200 feet in height above the ground level at its site.

(2) Any construction or alteration of greater height than imaginary surface extending outward and upward at one of the following slopes:

(i) 1 00 to 1 for horizontal distance of 20,000 feet from the nearest point of the nearest runway of each airport specified in paragraph (a)(5) of this section with at least one runway more than 3,200 feet in actual length, excluding heliports.

(ii) 50 to 1 for horizontal distance of 10,000 feet from the nearest point of the nearest runway of each airport specified in paragraph (a)(5) of this section with its longest runway no more than 3,200 feet in actual length, excluding heliports.

(iii) 25 to 1 for a horizontal distance of 5,000 feet from the nearest point of the nearest landing and takeoff area of each heliport specified in paragraph (a)(5) of this section.

(3) Any highway, railroad, or other traverse way for mobile objects, of a height which, if adjusted upward 17 feet for an Interstate Highway that is part of the National System of Military and Interstate Highways where overcrossings are designed for a minimum of 17 feet vertical distance, 16 feet for any other public roadway, 10 feet or the height of the highest mobile object that would normally traverse the road, whichever is greater, for a private road, 23 feet for a railroad, and for a waterway or any other traverse way not previously mentioned, an amount equal to the height of the highest mobile object that would normally traverse it, would exceed a standard of paragraph (a)(1) or (2) of this section.

(4) When requested by the FAA, any construction or alteration that would be in an instrument approach area (defined in the FAA standards governing instrument approach procedures) and available information indicates it might exceed a standard of Subpart C of this part.

(5) Any construction or alteration on any of the following airports (including heliports):

(i) An airport that is available for public use and is listed in the Airport Directory of the current Airmen's Information Manual or in either the Alaska or Pacific Airmen's Guide and Chart Supplement.

(ii) An airport under construction, that is the subject of a notice or proposal on file with the Federal Aviation Administration, and except for military airports, it is clearly indicated that airport will be available for public use.

(iii) An airport that is operated by an armed force of the United States.

(b) Each sponsor who proposes construction or alteration that is the subject of a notice under paragraph (a) of this section and is advised by an FAA regional office that a supplemental notice is required shall submit that notice on a prescribed form to be received by the FAA regional office at least 48 hours before the start of construction or alteration.

(c) Each sponsor who undertakes construction or alteration that is the subject of a notice under paragraph (a) of this section shall, within 5 days after that construction or alteration reaches its greatest height, submit a supplemental notice on a prescribed form to the FAA regional office having jurisdiction over the region involved, if –

(1) The construction or alteration is more than 200 feet above the surface level of its site; or

(2) An FAA regional office advises him that submission of the form is required.

### §77.15 Construction or alteration not requiring notice.

No person is required to notify the Administrator for any of the following construction or alteration:

(a) Any object that would be shielded by existing structures of a permanent and substantial character or by natural terrain or topographic features of equal or greater height, and would be located in the congested area of a city, town, or settlement where it is evident beyond all reasonable doubt that the structure so shielded will not adversely affect safety in air navigation.

(b) Any antenna structure of 20 feet or less in height except one that would increase the height of another antenna structure.

(c) Any air navigation facility, airport visual approach or landing air, aircraft arresting device, or meteorological device, of a type approved by the Administrator, or an appropriate military service on military airports, the location and height of which is fixed by its functional purpose.

(d) Any construction or alteration for which notice is required by any other FAA regulation.

### §77.17 Form and time of notice

(a) Each person who is required to notify the Administrator under §77.13 (a) shall send one executed form set of FAA Form 7460-1, Notice of Proposed Construction or Alteration, to the Manager, Air Traffic Division, FAA Regional Office having jurisdiction over the area within which the construction or alteration will be located. Copies of FAA Form 7460-1 may be obtained from the headquarters of the Federal Aviation Administration and the regional offices.

(b) The notice required under §77.13 (a)(1) through (4) must be submitted at least 30 days before the earlier of the following dates –

(1) The date the proposed construction or alteration is to begin.

(2) The date an application for a construction permit is to be filed.

However, a notice relating to proposed construction or alteration that is subject to the licensing requirements of the Federal Communications Act may be sent to the FAA at the same time the application for construction is filed with the Federal Communications Commission, or at any time before that filing.

(c) A proposed structure or an alteration to an existing structure that exceeds 2,000 feet in height above the ground will be presumed to be a hazard to air navigation and to result in an inefficient utilization of airspace and the applicant has the burden of overcoming that presumption. Each notice submitted under the pertinent provisions of this part 77 proposing a structure in excess of 2,000 feet above ground, or an alteration that will make an existing structure exceed that height, must contain a detailed showing, directed to meeting this burden. Only in exceptional cases, where the FAA concludes that a clear and compelling showing has been made that it would not result in an inefficient utilization of the airspace and would not result in a hazard to air navigation, will a determination of no hazard be issued.

(d) In the case of an emergency involving essential public services, public health, or public safety that required immediate construction or alteration, the 30 day requirement in paragraph (b) of this section does not apply and the notice may be sent by telephone, telegraph, or other expeditious means, with an executed FAA Form 7460-1 submitted within five (5) days thereafter. Outside normal business hours, emergency notices by telephone or telegraph may be submitted to the nearest FAA Flight Service Station.

(e) Each person who is required to notify the Administrator by paragraph (b) or (c) of §77.13, or both shall send an executed copy of FAA Form 7460-2, Notice of Actual Construction or Alteration, to the Manager, Air Traffic Division, FAA Regional Office having jurisdiction over the area involved.

Mail Processing Center  
 Federal Aviation Administration  
 Southwest Regional Office Obstruction Evaluation Service, AJR-322  
 2601 Meachum Boulevard  
 Fort Worth, TX 76193  
 Fax: 817-838-1991  
 Phone: 817-838-1990

Website: <https://oeaaa.faa.gov>



## INSTRUCTIONS FOR COMPLETING FAA FORM 7460-1

PLEASE TYPE or PRINT

**ITEM #1.** Please include the name, address and phone number of a personal contact point as well as the company name.

**ITEM #2.** Please include the name, address and phone number of a personal contact point as well as the company name.

**ITEM #3.** New Construction would be a structure that has not yet been built.

Alteration is a change to an existing structure such as the addition of a side mounted antenna, a change to the marking and lighting, a change to power and/or frequency, or a change to the height. The nature of the alteration shall be included in **ITEM #21** "Complete Description of Proposal".

Existing would be a correction to the latitude and/or longitude, a correction to the height, or if filing on an existing structure which has never been studied by the FAA. The reason for the notice shall be included in **ITEM #21** "Complete Description of Proposal".

**ITEM #4.** If Permanent, so indicate. If Temporary, such as a crane or drilling derrick, enter the estimated length of time the temporary structure will be up.

**ITEM #5.** Enter the date that construction is expected to start and the date that construction should be completed.

**ITEM #6.** Please indicate the type of structure. **DO NOT LEAVE BLANK.**

**ITEM #7.** In the event that obstruction marking and lighting is required, please indicate type desired. If no preference, check "other" and indicate "no preference" **DO NOT LEAVE BLANK.** **NOTE:** High Intensity lighting shall be used only for structures over 500' AGL. In the absence of high intensity lighting for structures over 500' AGL, marking is also required.

**ITEM #8.** If this is an existing tower that has been registered with the FCC, enter the FCC Antenna Structure Registration number here.

**ITEM #9 and #10.** Latitude and longitude must be geographic coordinates, accurate to within the nearest second or to the nearest hundredth of a second if known. Latitude and longitude derived solely from a **hand-held GPS instrument is NOT acceptable.** A hand-held GPS is only accurate to within 100 meters (328 feet) 95 percent of the time. This data, when plotted, should match the site depiction submitted under **ITEM #20.**

**ITEM #11.** NAD 83 is preferred; however, latitude and longitude may be submitted in NAD 27. Also, in some geographic areas where NAD 27 and NAD 83 are not available other datums may be used. It is important to know which datum is used. **DO NOT LEAVE BLANK.**

**ITEM #12.** Enter the name of the nearest city and state to the site. If the structure is or will be in a city, enter the name of that city and state.

**ITEM #13.** Enter the full name of the nearest public-use (*not private-use*) airport or heliport or military airport or heliport to the site.

**ITEM #14.** Enter the distance from the airport or heliport listed in #13 to the structure.

**ITEM #15.** Enter the direction from the airport or heliport listed in #13 to the structure.

**ITEM #16.** Enter the site elevation above mean sea level and expressed in whole feet rounded to the nearest foot (e.g. 17'3" rounds to 17', 17'6" rounds to 18'). This data should match the ground contour elevations for site depiction submitted under **ITEM #20.**

**ITEM #17.** Enter the total structure height above ground level in whole feet rounded to the next highest foot (e.g. 17'3" rounds to 18'). The total structure height shall include anything mounted on top of the structure, such as antennas, obstruction lights, lightning rods, etc.

**ITEM #18.** Enter the overall height above mean sea level and expressed in whole feet. This will be the total of **ITEM #16 + ITEM #17.**

**ITEM #19.** If an FAA aeronautical study was previously conducted, enter the previous study number.

**ITEM #20.** Enter the relationship of the structure to roads, airports, prominent terrain, existing structures, etc. Attach an 8-1/2" x 11" non-reduced copy of the appropriate 7.5 minute U.S. Geological Survey (USGS) Quadrangle Map MARKED WITH A PRECISE INDICATION OF THE SITE LOCATION. To obtain maps, contact USGC at 1-800-435-7627 or via internet at "<http://mapping.usgs.gov>". If available, attach a copy of a documented site survey with the surveyor's certification stating the amount of vertical and horizontal accuracy in feet.

**ITEM #21.**

- For transmitting stations, include maximum effective radiated power (ERP) and all frequencies.
- For antennas, include the type of antenna and center of radiation (*Attach the antenna pattern, if available*).
- For microwave, include azimuth relative to true north.
- For overhead wires or transmission lines, include size and configuration of wires and their supporting structures (*Attach depiction*).
- For each pole/support, include coordinates, site elevation, and structure height above ground level or water.
- For buildings, include site orientation, coordinates of each corner, dimensions, and construction materials.
- For alterations, explain the alteration thoroughly.
- For existing structures, thoroughly explain the reason for notifying the FAA (*e.g. corrections, no record or previous study, etc.*).

Filing this information with the FAA does not relieve the sponsor of this construction or alteration from complying with any other federal, state or local rules or regulations. If you are not sure what other rules or regulations apply to your proposal, contact local/state aviation and zoning authorities.

**Paperwork Reduction Work Act Statement:** This information is collected to evaluate the effect of proposed construction or alteration on air navigation and is not confidential. Providing this information is mandatory for anyone proposing construction or alteration that meets or exceeds the criteria contained in 14 CFR, part 77. We estimate that the burden of this collection is an average 19 minutes per response. An agency may not conduct or sponsor, and a person is not required to respond to a collection of information unless it displays a currently valid OMB control number. The OMB control number for this collection is 2120-0001. Comments concerning the accuracy of this burden and suggestions for reducing the burden should be directed to the FAA at: 800 Independence Ave. SW, Washington, DC 20591, Attn: Information Collection Clearance Officer, ABA-20



Form Approved OMB No. 2120-0001  
Expiration Date: 9/30/2010

Please Type or Print on This Form

**U.S. Department of Transportation  
Federal Aviation Administration**  
**Failure To Provide All Requested Information May Delay Processing of Your Notice**  
**Notice of Proposed Construction or Alteration**  
**FOR FAA USE ONLY**  
Aeronautical Study Number

**1. Sponsor (person, company, etc. proposing this action):**  
Attn. of: \_\_\_\_\_  
Name: \_\_\_\_\_  
Address: \_\_\_\_\_  
City: \_\_\_\_\_ State: \_\_\_\_\_ Zip: \_\_\_\_\_  
Telephone: \_\_\_\_\_ Fax: \_\_\_\_\_

**9. Latitude:** \_\_\_\_\_° \_\_\_\_\_' \_\_\_\_\_"  
**10. Longitude:** \_\_\_\_\_° \_\_\_\_\_' \_\_\_\_\_"  
**11. Datum:**  NAD 83  NAD 27  Other  
**12. Nearest:** City: \_\_\_\_\_ State \_\_\_\_\_  
**13. Nearest Public-use** (not private-use) or Military Airport or Heliport: \_\_\_\_\_

**2. Sponsor's Representative (if other than #1):**  
Attn. of: \_\_\_\_\_  
Name: \_\_\_\_\_  
Address: \_\_\_\_\_  
City: \_\_\_\_\_ State: \_\_\_\_\_ Zip: \_\_\_\_\_  
Telephone: \_\_\_\_\_ Fax: \_\_\_\_\_

**14. Distance from #13.** to Structure: \_\_\_\_\_  
**15. Direction from #13.** to Structure: \_\_\_\_\_  
**16. Site Elevation (AMSL):** \_\_\_\_\_ ft.  
**17. Total Structure Height (AGL):** \_\_\_\_\_ ft.  
**18. Overall Height (#16 + #17) (AMSL):** \_\_\_\_\_ ft.  
**19. Previous FAA Aeronautical Study Number** (if applicable): \_\_\_\_\_ -OE

**3. Notice of:**  New Construction  Alteration  Existing  
**4. Duration:**  Permanent  Temporary ( \_\_\_\_\_ months, \_\_\_\_\_ days)  
**5. Work Schedule:** Beginning \_\_\_\_\_ End \_\_\_\_\_  
**6. Type:**  Antenna Tower  Crane  Building  Power Line  
 Landfill  Water Tank  Other \_\_\_\_\_  
**7. Marking/Painting and/or Lighting Preferred:**  
 Red Lights and Paint  Dual - Red and Medium Intensity White  
 White - Medium Intensity  Dual - Red and high Intensity White  
 White - High Intensity  Other  
**8. FCC Antenna Structure Registration Number** (if applicable): \_\_\_\_\_

**20. Description of Location:** (Attach a USGS 7.5 minute Quadrangle Map with the precise site marked and any certified survey)

**21. Complete Description of Proposal:**

Frequency/Power (kW)	

Notice is required by 14 Code of Federal Regulations, part 77 pursuant to 49 U.S.C., Section 44718. Persons who knowingly and willingly violate the notice requirements of part 77 are subject to a civil penalty of \$1,000 per day until the notice is received, pursuant to 49 U.S.C., Section 46301(a)  
I hereby certify that all of the above statements made by me are true, complete, and correct to the best of my knowledge. In addition, I agree to mark and/or light the structure in accordance with established marking & lighting standards as necessary.  
Date \_\_\_\_\_ Typed or Printed Name and Title of Person Filing Notice \_\_\_\_\_ Signature \_\_\_\_\_





## Appendix B

### TERMINOLOGY DEFINITIONS

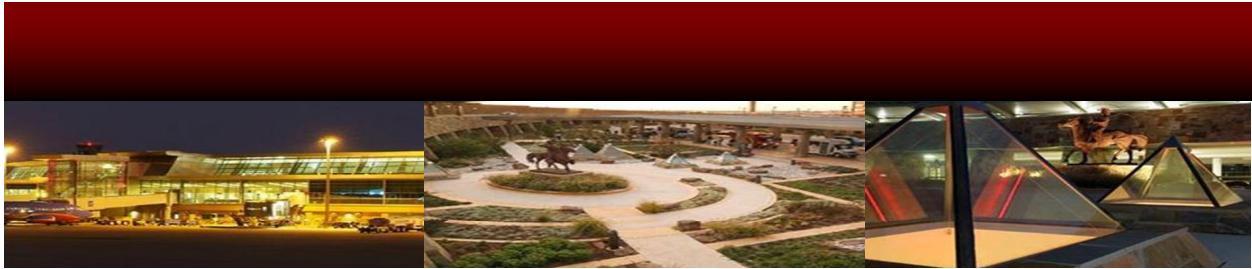

## **Airport**

The physical property of the Will Rogers World Airport.

## **Airfield**

Includes ramp, apron, taxi lanes, taxiways, runways, and the internal areas that separate these areas.

## **Airside Property and Uses**

Airport property and activities which require or desire access to the runway, taxiway, or apron system.

## **Building Coverage**

The surface area of a building site that may be covered by buildings, expressed as a percentage of the total site area.

## **Buildings**

The main portion of each structure including all projections, extensions, additions, changes, garages, outside platforms and docks, canopies, eaves, and porches. Paving, ground cover, fences, signs and landscaping are specifically excluded from this definition.

## **Building Site**

The land included in the lease agreement.

## **Building Restriction Line**

The distance from the centerline of the runway within which no permanent structure can be built. The area is governed by the Obstacle Limitation Surfaces. This defined distance is intended to protect aircraft in flight and the location and operation of navigational aids and for maintaining instrument flight procedures.

## **Building Setback Line**

The minimum distance which all buildings and structures shall be set back from the lease line adjacent to taxiways, access roads and streets.

## **Corner Building Site**

A building site which has two or more property lines abutting a street.

## **Development Center**

The City Of Oklahoma City Public Works Development Center provides for the effective implementation and maintenance of ordinances and policies related to land use codes and building regulations. The division is responsible for reviewing all building plans for compliance with relevant codes and ordinances,



collecting fees and issuance of permits for all construction related activity, inspecting all structures for safety and code compliance; and enforcing Building Code Requirements.

### **Development Standards**

Guidelines for the development of individual sites in a manner which will enhance the working efficiency and visual amenities of the Airport.

### **Front Lot Line**

The lease boundary line that faces a street. On a corner lot or lots fronting on two parallel streets, the front lot line shall mean the property lines facing each street.

### **Improvements**

All buildings, structures, and facilities including paving, fencing, signs and landscaping constructed, installed, or placed on, under, or above any building site by or on the account of a tenant.

### **Landscaping**

The aesthetic improvement of building sites through the use of lawns, ground cover, trees, and shrubs, as well as walls, screening, and terraces.

### **Landside Property and Uses**

Property and uses which do not adjoin the airfield.

### **Land Use Plan**

The most recent plan for the future of development of the Airport adopted by WRWA wherein various segments of airport land are reserved for specific uses.

### **Lease Line**

The boundary which limits the extent of a particular parcel of land, as described in the lease.

### **WRWA**

The staff of Will Rogers World Airport.

### **Property Lines**

For the purpose of this document, perimeter lines of each building site are property lines. This definition may or may not agree with the language of the lease documents.

### **Rear Lot Line**

The property line generally paralleled to the front lot line and contiguous to another lot. On corner lots, the rear lot line shall be parallel to one front lot line.



### **Rear Lease Line**

The lease line describing the rear boundary of a tenant's parcel, opposite the lease line fronting the taxiway or street opposite the main entrance.

### **Screening**

Plant materials, berms, fences, or walls of wood, masonry or other materials of sufficient height and capability to obscure the view of a particular function or area from the street or land use on adjacent properties.

### **Setback Area**

The minimum required area situated between a property line and a setback line:

*"Front setback area"* means the area between the street on which a building site abuts and the front setback line and extends from the side lease boundary line to side boundary line. On a corner building site, the front setback area shall apply to each lease boundary line abutting a street, unless otherwise specified.

*"Side setback area"* means the area between the side property line and the side setback line and extends from the front setback line to the rear setback line.

*"Rear setback area"* means the area between the rear property line and the rear setback line and extends from side boundary line to side lease boundary line.

### **Setback Line**

A line of building site lying parallel to each lease boundary line and separate from it by the distance required to provide the minimum setback area.

### **Side Lease Line**

The lease line at a perpendicular or oblique angle to the front lease line.

### **Site Coverage**

The portion of the total building site area that may be covered by the building(s).

### **Site Width**

The diameter of the largest circle which can be inscribed within the lease boundary lines of a building site.

### **Street**

The paved portion of a carriageway used for vehicular access to the building site and used as a thoroughfare by the public.





### **Taxiway**

An aircraft maneuvering area including a taxiway, apron, ramp or any right-of-way for aircraft whose edge is the edge of the right-of-way for all purposes of these standards.

### **Tenant**

Individuals and organizations which have leased property which is subject to regulation or control by the Airport.

### **Variance**

A written notification by the Airport which modifies one or more specific standard(s) of the development as they apply to a particular lot and particular tenant